



**HDS1021M Handheld Digital Storage
Oscilloscope & Multimeter
User Manual**

WWW.OWON.COM.CN

Dec. 2009 edition

Copy Right in this Manual © Lilliput Company. All rights have been reserved.

The Lilliput's products are under the protection of the patent rights in America and other countries, including ones which have already obtained the patent rights and those which are applying for. The information in this manual will replace all that in the materials published originally.

The information in this manual was correct at the time of printing. However, OWON will continue to improve products and reserves the rights to changes specification at any time without notice.

OWON is the registered trademark of the Lilliput Company.

Xiamen Lilliput Technology Co.,Ltd.: the 5th floor, B Area, Chuangxin Mansion, Software Park,ZhenZhuWan, Huandao RD, Xiamen,Fujian,China

Fujian Lilliput Optoelectronics Technology Co.,Ltd.:The mansion of optoelectronics hengsan road, Lantian industrial zone ,Zhangzhou,Fujian,China

Tel:+86-592-2575666

Fax:+86-592-2575669

Mail:sales@owon.com.cn

General Warranty

The Lilliput warrants that the product will be free from defects in materials and workmanship for a period of three years from the date of purchase of the product by the original purchaser from the Lilliput company. And the warranty period of accessories such as probe, battery, adapter is one year. This warranty only applies to the original purchaser and is not transferable to the third party. If the product proves defective during the warranty period, Lilliput either will repair the defective product without charge for parts and labor, or will provide a replacement in exchange for the defective product. Parts, modules and replacement products used by Lilliput for warranty work may be new or reconditioned to like new performance. All replaced parts, modules and products become the property of Lilliput.

In order to obtain service under this warranty, Customer must notify Lilliput of the defect before the expiration of the warranty period. Customer shall be responsible for packaging and shipping the defective product to the service center designated by Lilliput, and with a copy of customer proof of purchase.

This warranty shall not apply to any defect, failure or damage caused by improper use or improper or inadequate maintenance and care. Lilliput shall not be obligated to furnish service under this warranty a) to repair damage resulting from attempts by personnel other than Lilliput representatives to install, repair or service the product; b) to repair damage resulting from improper use or connection to incompatible equipment; c) to repair any damage or malfunction caused by the use of non-Lilliput supplies; or d) to service a product that has been modified or integrated with other products when the effect of such modification or integration increases the time or difficulty of servicing the product.

Please contact the nearest Lilliput's Sales and Service Offices for services or a complete copy of the warranty statement.

Excepting the after-sales services provided in this summary or the applicable warranty statements, Lilliput will not offer any guarantee for maintenance definitely declared or hinted, including but not limited to the implied guarantee for marketability and special-purpose acceptability. Lilliput should not take any responsibilities for any indirect, special or consequent damages.

Table of Contents

Chapter	Page
1.DECLARATION OF CONFORMITY	1
1.1 Declaration of Conformity	1
1.2 Open the Oscilloscope Parts Box,You Can See the Parts Below (see the picture below)	1
2.SAFETY INFORMATION	2
2.1 Safety Terms and Symbols	2
2.1.1 Specific Warning and Caution Terms that Appear throughout the Manual	2
2.1.2 Terms Used on the Product	2
2.1.3 Symbols Used on the Product.	2
2.2 General Safety Information	3
3. GENERAL CHARACTERISTICS	5
4.PERFORMING THE GENERAL INSPECTION	6
4.1 Performing the General Inspection	6
4.1.1 Check whether there is any Damage on it Due to Transportation	6
4.1.2 Make a Check on Accessories	6
4.1.3 Make a Check on the Complete Instrument	6
5.INPUT CONNECTIONS	7
5.1 Input Connections	7
5.2 Description for Front Panel and Keys	8
6.USING THE SCOPE	10
6.1 About this Chapter	10
6.2 Power-Up the Oscilloscope	10

6.3 Oscilloscope Operation Window	10
6.4 Navigating a Menu	12
6.5 Manually Setting the Vertical System, Horizontal System and Trigger Position	12
6.6 Resetting the Oscilloscope	14
6.7 Input Connections	15
6.8 Displaying an Unknown Signal with Auto Set	15
6.9 Automatic Zero-returning of Trigger Horizontal Position and 50% setting of Trigger Level Position	16
6.10 Automatic Measurements	16
6.11 Freezing the Screen	17
6.12 Using Average for Smoothing Waveforms	17
6.13 Using Persistence to Display Waveforms	18
6.14 Using Peak Detection to Display Glitches	19
6.15 Selecting AC-coupling	20
6.16 Reversing the Polarity of the Displayed Waveform	21
7.USING THE MULTIMETER	22
7.1 About this Chapter	22
7.2 Making Meter Connections	22
7.3 Multimeter Operation Window	22
7.4 Making Multimeter Measurements	23
7.4.1 Measuring Resistance Values	24
7.4.2 Making a Diode Measurement	24
7.4.3 On-off Test.....	25
7.4.4 Making a Capacitance Measurement	26
7.4.5 Making a DC Voltage Measurement	26
7.4.6 Making a AC Voltage Measurement.....	27
7.4.7 Making a DC Current Measurement	28
7.4.8 Making an AC Current Measurement	29

7.5 Freezing the Readings	30
7.6 Taking a Relative Measurement	31
7.7 Selecting Automatic/Manual Range Adjustment	32
8.ADVANCED FUNCTION OF OSCILLOSCOPE	3 3
8.1 About this Chapter	3 3
8.2 Setting the Channel	3 3
8.2.1 Setting the Channel Coupling	3 4
8.2.2 Make Open and Close Settings on Channel	3 5
8.2.3 Adjusting the Probe Scale	3 5
8.2.4 Setting of Inverted Waveform	3 6
8.3 Setting the Trigger System	3 6
8.4 Triggering Control	3 7
8.4.1 Edge Triggering	3 7
8.4.2 Video Triggering	3 8
8.5 Acquiring Mode Setting	4 0
8.6 Display Setting	4 0
8.6.1 Display Style	4 1
8.6.2 Persistence	4 1
8.6.3 Cymometer	4 2
8.7 Waveform Saving Setups	4 2
8.8 Function Setting Menu	4 3
8.9 Making Automatic Measurements	4 4
8.10 Setting the Cursor Measurements	4 6
8.11 Autoscale	4 8
8.12 System State Menu	5 0
8.13 Setting of Time Base Mode	5 0
8.14 Data Transmission	5 1
9.TROUBLE SHOOTING	53

10.APPENDIX.....54

10.1 Appendix A: Specifications.....54

 10.1.1 Oscilloscope54

 10.1.2 Meter56

 10.1.3 General Specifications.....57

10.2 Appendix B: Maintenance and Cleaning58

 10.2.1 Common Maintenance58

 10.2.2 Storage of Oscilloscope.....59

 10.2.3 Replacing the Lithium Battery Unit.....59

1.Declaration of Conformity

1.1 Declaration of Conformity

HDS1021M Handheld Digital Storage Oscilloscope & Multimeter

Manufacturer: Fujian Lilliput Optoelectronic Technology Co., Ltd.

Statement of Conformity

Base on the result using appropriate standards,the product is in conformity with
Electromagnetic Compatibility Directive 89/336/EEC
Low Voltage Directive 73/23/EEC

Sample tests

Standards used:

EN61010.1: 2001 (2nd edition)

Safety Requirements for Electrical Equipment for Measurement, Control, and
Laboratory use-part 1:General Requirements

EN61326: 1997+A1: 1998+A2: 2001+A3: 2003

Electrical Equipment for Measurement, Control and Laboratory use-EMC
Requirements-part 1. General Requirements

EN61000-3-2: 2000+A2: 2005

Electromagnetic Compatibility(EMC)-part 3:Limits-Section 2:Limits for Harmonic
Current Emissions (Equipment Input Current less than/equal to 16A per phase)

EN61000-3-3: 1995+A1: 2001

Electromagnetic Compatibility (EMC)-part 3:Limits-Section 3 Limitation of Voltage
Fluctuations and Flicker in Low-Voltage Supply systems for Equipment with Rated
Current less than or equal to 16A

The tests have been performed in typical configuration.

This conformity is indicated by the symbol CE, i.e."Conformite Europeenne".

1.2 Open the Oscilloscope Parts Box, You Can See the Parts Below (see the picture below)

#	Description	Standard	Optional
1	Oscilloscope and Battery	●	
2	Power adapter	●	
3	Oscilloscope Probe x 1 (grey)	●	
4	Multimeter test lead x 2 (black and red)	●	
5	Extension module for big current measurement	●	
6	Module for small capacitance measurement	●	
7	The output terminal of 1KHz/5v signal	●	
8	Probe adjustment tools	●	
9	USB communication cable	●	
10	User Manual	●	
11	CD-ROM (software)	●	
12	Soft carrying case		●



figure 1: Digital Oscilloscope Parts

2.Safety Information

In order to ensure the correct using and the best efficient service, please carefully read this user's manual.

2.1 Safety Terms and Symbols

2.1.1 Specific Warning and Caution Terms that Appear throughout the Manual

 **Warning:** “Warning” identifies conditions and actions that pose hazards to the users.

 **Caution:** “Caution” identifies conditions and actions that may damage the product or other properties.

2.1.2 Terms Used on the Product

The following terms appears possibly on the product:

Danger: The term “Danger” is used in this manual to indicate that when you read this mark, personal injury may be caused to you immediately.

Warning: The term “Warning” is used in this manual to indicate that when you read this mark, personal injury may not be caused to you immediately, but you need to be cautionary.

Notice: The term “Notice” is used in this manual to indicate that damages may be caused on this product or other properties.

2.1.3 Symbols Used on the Product.

The following symbols appear possibly on the product.



High Voltage



Please Consult the Manual.



Protective Ground End



Earth End on the Shell



Grounding End for Measurement

2.2 General Safety Information

Carefully read the following safety information in order to avoid any personal injury and damage on this product or any products connected with it. This product can only be used in the specified applications to prevent any possible dangers.



Warning:

To avoid fire or electrical shock. Please use proper power adapter. Use only the power adapter appointed by the manufacturer and subject to approval of being used in the user's country.



Warning:

To avoid fire or electrical shock if a test tool input is connected to more 42V peak (30Vrms) or on circuits of more than 4800VA:

- Use only insulated voltage probes, test leads and adapter supplied with the test tool, or indicated by OWON as suitable for the Oscilloscope & Multimeter.
- Before use, inspect voltage probes, test leads and accessories for mechanical damage and replace when damaged.
- Remove all probes, test leads and accessories (power adapter , USB line)that are not in use.
- Do not apply voltages that differ more than 400 V from earth ground to any input when measuring in a CAT II environment.
- Do not apply voltages that differ more than 400 V from each other to the isolated inputs when measuring in a CAT II environment.
- Do not apply input voltages above the rating of the instrument Use caution when using 1:1 test leads because the probe tip voltage will be directly transmitted to the Oscilloscope & Multimeter.
- Do not use exposed metal BNC or banana plug connectors.
- Do not insert metal objects into connectors.
- Always use the Oscilloscope & Multimeter only in the manner specified.
- Voltage ratings that are mentioned in the warning, are given as limits for “working voltage”. The represent V ac rms (50-60Hz) for AC sine wave applications and as V dc for DC applications. Overvoltage Category II refers to local level , CAT is the prefix refers to level II, Class II is a low-voltage high-energy level, which is applicable for appliances and portable equipment .

Only qualified technical personnel are permitted to perform maintenance.

Always connect the power adapter first to the AC outlet before connecting it to the

Oscilloscope & Multimeter.

Pay attention to the nominal values of all terminals:To avoid fire or electric shock, please keep a watchful eye on all nominal values and marks specified for this product. Before any connection performed on this product, carefully read the user's manual of the product for further information of nominal values.

No operation is allowed without the instrument cover plate: If the cover plate or panel has been removed, do not perform any operation on this product.

No touch is allowed on bare conductors:When the product is powered on, do not touch any bare joints or parts of the scope meter.

Operation is prohibited in case of any undetermined failure:When in doubt any damage on this product, consult the qualified personnel for checking on it.

Keep ventilation in good condition:Refer to the user manual for detail installation instructions in order to fix this product correctly and provide it with good ventilation conditions.

No operation is allowed under a humid environment.

No operation is allowed under an explosive environment.

Keep clean and dry on the product surface.

The method which stipulated according to the factory does not use the equipment, possibly can damage the protection which the equipment provides.

3. General Characteristics

Oscilloscope

- Record length of 6,000 points;
- Reading-out with the cursor;
- Eighteen automatic measurement functions;
- Autoscale function;
- Color liquid crystal display of high resolution and high contrast;
- Storage and call-out of waveforms;
- Automatic setting function provided capable of fast setting;
- Implementation of detecting the average and peak values of the waveform;
- Edge and video triggering function;
- USB communication port;
- Multiple Language User Interface.

Multimeter

- 3 3/4 digits;
- Volts,Amps,Ohms,Diode,Capacitance,Continuity measurement;
- 20A maximum amplitude;
- Isolated inputs between oscilloscope and multimeter.

4.Performing the General Inspection

4.1 Performing the General Inspection

When you have got a new HDS1021M series oscilloscope, it is suggested that you should perform a general inspection on the instrument according to the following steps.

4.1.1 Check whether there is any Damage on it Due to Transportation

If the packing boxes or foam cushions are found in serious damage, keep them in a proper place till the complete instrument and accessories have passed the electrical and mechanical tests.

4.1.2 Make a Check on Accessories

The accessory list has been described in the picture of Digital Oscilloscope Parts of this manual. You can make a check and find whether there is any accessory loss with reference to the Appendix. In case of any accessory loss or damage, consult the OWON dealer responsible for such a business or the local office of OWON.

4.1.3 Make a Check on the Complete Instrument

If the instrument is damaged in its appearance or it fails in normal operation or performance test, consult the OWON dealer responsible for such a business or the local office of OWON. If the instrument is damaged due to transportation, keep the packing in a proper place and consult the transportation department and the OWON dealer responsible for such business, who will provide an instrument replacement or maintenance.

5.Input Connections

5.1 Input Connections

See the following figure 2:



figure 2

Description:

1. The power adapter is supplied for AC power supply and battery recharging.
2. Multimeter test lead.
3. Multimeter input jacks, including three circular banana jacks and two square jacks.
The three circular jacks are used for voltage, current and resistance inputs, while the two square jacks are used for capacitance inputs.
4. Oscilloscope probe.
5. Oscilloscope channel input.
6. The output terminal of 1KHz/5V square-wave test signal.

5.2 Description for Front Panel and Keys

See the following figure 3:



figure 3

Description:

1. Power adapter jack.
2. USB jack.
3. The output port of 1KHz/5V square-wave test signal.
4. : Power switch.
5. A: Multimeter current measurement key.
6. V: Multimeter voltage measurement key.
7. R: Multimeter resistance, triode, On/Off and capacitance measurement key.
8. OSC ◀: Oscilloscope left-direction adjustment key.
9. OSC ▶: Oscilloscope right-direction adjustment key.
10. OSC OPTION: Oscilloscope setting key.

- With the combination application of the four keys OSC ◀, OSC ▶, OSC ▲ and OSC ▼, the users can make the following settings circularly by pressing OSC OPTION. The settings include: Voltage Unit Scale of Channel; Primary Time base (TIME BASE), zero point position of channel, trigger horizontal position (TIME) and trigger level position (TRIG).
 - In cursor measurement mode, the users can adjust the positions of Cursor 1(V1 or T1) and Cursor 2 (V2 or T2).
11. OSC ▼: Oscilloscope display downward adjustment key.
 12. OSC ▲: Oscilloscope display upward adjustment key.
 13. OSC/DMM: Operation mode switching key between oscilloscope and multimeter.
 14. AUTO SET:
 - Under the Multimeter Mode, when performing the current or voltage measurement, you can make a measurement switch between AC and DC with this key pressed; when performing the resistance measurement, you can select resistance, diode, On/Off or capacitance measurement circularly with this key.
 - While this key is used for auto setting under the oscilloscope operation mode.
 15. RUN/STOP: key for running or stopping the operation.
 16. MENU ▼: Choose the lower item on the menu list.
 17. MENU: Show / Hide the menu.
 18. MENU ▲: Choose the upper item on the menu list.
 19. F1~F5: Switch or Adjust options for each menu.

6.Using the Scope

6.1 About this Chapter

This chapter provides a step-by-step introduction to the scope functions. The introduction does not cover all of the capabilities of the scope functions but gives basic examples to show how to use the menus and perform basic operations.

6.2 Power-Up the Oscilloscope

Connect oscilloscope to AC power via a power adapter as shown in Figure 1. (The oscilloscope may still work with built-in Li-ion battery even without AC power supply)

Turn the oscilloscope on by pressing down the power on/off key .

The instrument then performs selfchecking after power on. A greeting window and a sentence “press any key to continue……” will display on the screen when the system finishes selfchecking.

The users can press any key to enter the measuring function.

The oscilloscope is powered up in its last setup configuration.

6.3 Oscilloscope Operation Window

See the following figure 4:

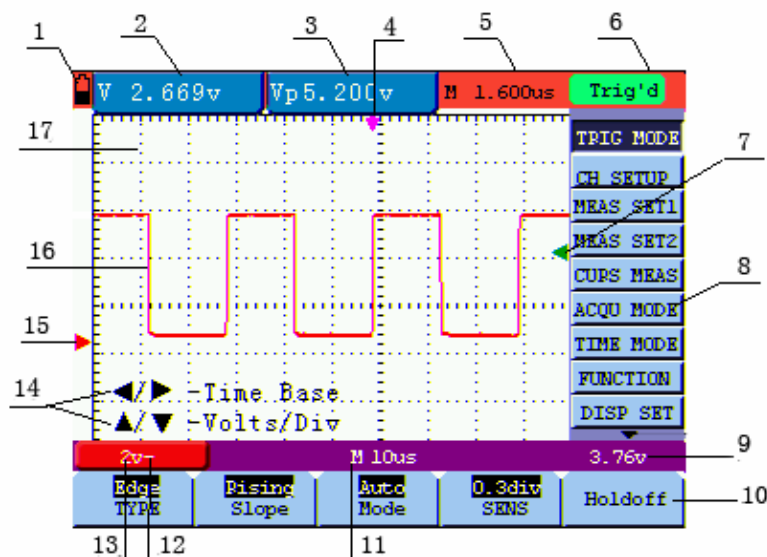





figure 4: Oscilloscope Operation Window

Description:

1. Battery electric quantity indicating symbols, including , ,  and .

2. Auto measurement window 1, in which “f” means frequency, “T” means cycle, “V” means the average value, “Vp” the peak-peak value, “Vk” the root-mean-square value, “Ma” the maximum amplitude value, “Mi” the minimum amplitude value, “Vt” the Voltage value of the waveform’s flat top value, “Vb” the Voltage value of the waveform’s flat base, “Va” the amplitude value, “Os” the overshoot value, “Ps” the Preshoot value, “RT” the rise time value, “FT” the fall time value, “PW” the +width value, “NW” the -Width value, “+D” the +Duty value, “-D” the -Duty value.
3. Auto measurement window 2.
4. The pointer indicates the horizontal triggering position.
5. This reading gives the Time Difference between the horizontal triggering position and the screen centerline. It reads zero when the pointer is in the center of the screen.
6. The trigger state indicates the following information.
 - Auto:** The oscilloscope is working in the automatic mode and displaying the waveform under the non-trigger state.
 - Trig’d:** The oscilloscope has detected a trigger and collecting the information generated after the trigger.
 - Ready:** All pre-triggered data have been captured and the oscilloscope has been ready to receive trigger signals.
 - Scan:** The oscilloscope can gather and display the waveform data continuously in scanning mode.
 - Stop:** The oscilloscope has stopped collecting the waveform data.
7. The green pointer shows the trigger voltage level.
8. A hidden-style menu: With the **MENU** key pressed, you can view or hide the menu.
9. It reads the value of trigger voltage level.
10. Menu setting options: There are different setting options for different menus.
11. The reading gives the value of primary time base.
12. These graphics present the coupling modes of the channel. The graphic “~” indicates AC, the graphic “—” indicates DC, the graphic “ $\frac{\perp}{\equiv}$ ” indicates GND.
13. This reading shows the vertical Voltage Unit Scale of the channel.
14. OSC OPTION operation prompt: There are different prompts for different OSC OPTION operations.
15. The red pointer gives the grounding datum point of the waveform, which is the zero position. No display of this pointer indicates that the channel has not been opened.
16. Waveform of the input signal.

17. Waveform display area.

6.4 Navigating a Menu

The following example shows how to use the tool's menus to select a function, as shown in the following figure.

1. Press the **MENU** key to display the Function Menu on the right of the screen and the corresponding optional settings on the bottom. Press **MENU** again will hide the Function Menu.
2. Press the **MENU ▲** or **MENU ▼** key to select different function menus.
3. Choose one key from **F1** to **F5** and press it to change function setting.

See the following figure 5:

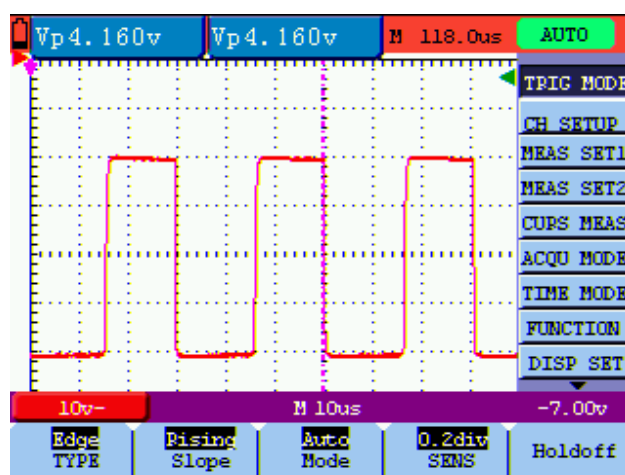

figure 5: the Tool's Menus

6.5 Manually Setting the Vertical System, Horizontal System and Trigger Position

With the combination application of the four keys **OSC ◀**, **OSC ▶**, **OSC ▲** and **OSC ▼**, the users can make the following settings circularly by pressing **OSC OPTION**. The settings include: Voltage Unit Scale of the Channel; Primary Time base (**TIME BASE**), zero point position of channel, trigger horizontal position (**TIME**) and trigger level position (**TRIG**).

The following example shows how to use **OSC OPTION** key to make a setting.

1. Press once the **OSC OPTION** key; the following is displayed at the bottom left side of the screen, as shown in the figure below.

◀/▶ – Time Base

▲/▼ – Volts/Div

See the following figure 6:

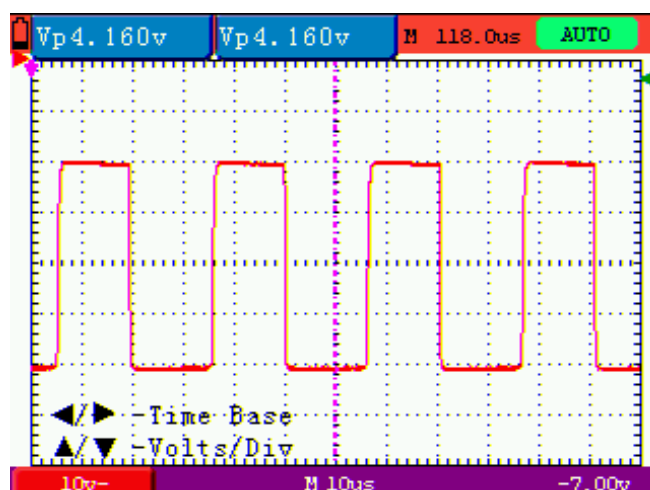

figure 6: Voltage Unit Scale

2. Press the key **OSC ▲** or **OSC ▼** to adjust the vertical scale and press **OSC ◀** or **OSC ▶** to adjust the horizontal time scale.
3. Press the **OSC OPTION** key one more time, and the following display is visible at the bottom left side of the screen, shown as the following figure.

◀/▶ – **Time**

▲/▼ – **Zero**

See the following figure 8:

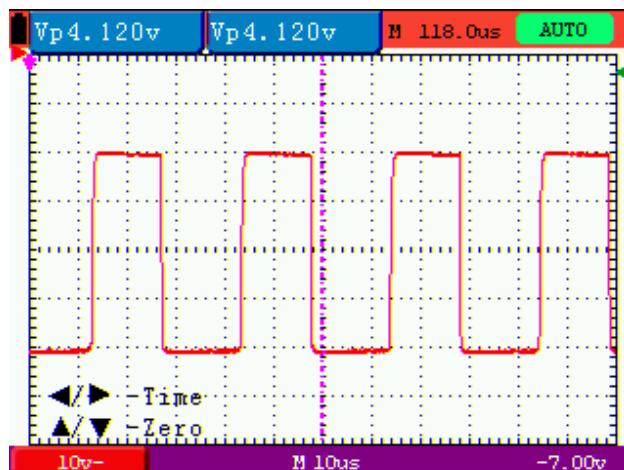

figure 7: Zero Point Position

6. Press **OSC ▲** or **OSC ▼** key to adjust the zero position in vertical direction and press **OSC ◀** or **OSC ▶** key to adjust the horizontal position.
9. Press **OSC OPTION** key once more and the following appears at the bottom left of the screen, shown as the following figure.

◀/▶ – Time

▲/▼ – Trig

See the following figure 8:

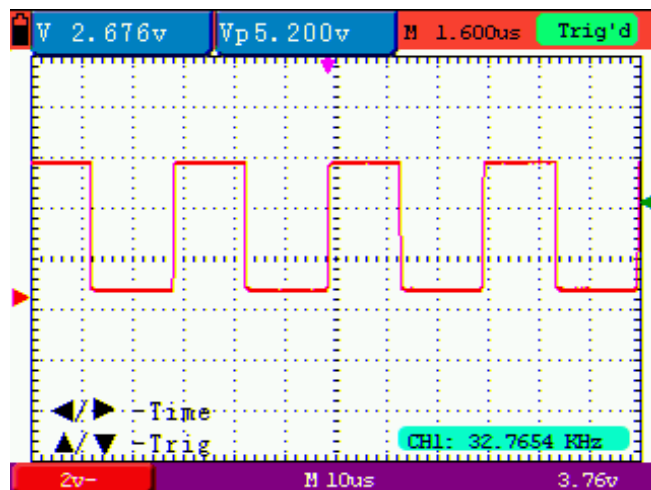

figure 8: Trigger Level Position

10. Press the **OSC ▲** or **OSC ▼** key to adjust the trigger position and press **OSC ◀** or **OSC ▶** key to adjust the horizontal position.
11. Press the **OSC OPTION** key again and return back to step 1.

Term interpretation

- **Vertical scale factor:** It stands for the voltage amplitude represented by a division in the vertical direction of the display area, through the adjustment of which you can amplify or attenuate the signal and thus regulate the signal amplitude into the expected measurement range.
- **Vertical zero position:** It is referred to as the grounding datum point, through the adjustment of which you can regulate the display position of the waveform on the screen.
- **Primary time base:** It means the time values represented by a division in the horizontal direction of the display area.
- **Trigger horizontal position:** It means the time deviation between the actual trigger point and the screen central line, which will be displayed as 0 at the center point of the screen.
- **Trigger level position:** It represents the voltage deviation between the actual trigger level and the zero position of the triggering signal source channel.

6.6 Resetting the Oscilloscope

If you want to reset the Oscilloscope to the factory settings, do the following:

1. Press **MENU** key and the function menu appears on the right side of the screen

2. Press the **MENU ▲** or **MENU ▼** key to select **FUNCTION** setting and three options are visible at the bottom of the screen.
3. Press **F1** key to select the factory settings. The oscilloscope is set to be the factory settings.

See the following figure 9:

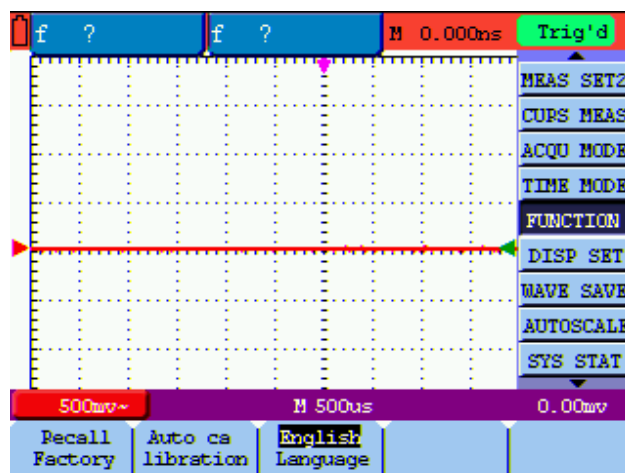

figure 9: Reset the Oscilloscope

6.7 Input Connections

See figure 2.

Look at the bottom and the right of the Oscilloscope. The Oscilloscope has six signal inputs: one safety BNC jack inputs for scope measurements, three safety 4-mm banana jack inputs for Multimeter R, V and A measurements, and two quadratic jack inputs for Multimeter capacitance measurements.

Isolated input allows independent floating measurements between Multimeters and Scopes.

6.8 Displaying an Unknown Signal with Auto Set

The Auto-Set feature lets the Oscilloscope display and measure unknown signals automatically. This function optimizes the position, range, time base, triggering and assures a stable display of virtually any waveform. This feature is especially useful for quickly checking several signals.

To enable the Auto-Set feature, do the following:

1. Connect the test probe to the tested signals.
2. Press the **AUTO SET** key and the Oscilloscope is under the automatic measurement condition. The tested signals appear on the screen.

6.9 Automatic Zero-returning of Trigger Horizontal Position and 50% setting of Trigger Level Position

When we adjust the trigger horizontal position and trigger level position to be maximal to make it off the screen center remotely, then we perform the following steps to make trigger horizontal position return to zero and trigger level position set to 50% automatically.

1. Press “V” key, the trigger horizontal position automatically returns to zero.
2. Press “R” key, the trigger level position automatically sets to 50%.

6.10 Automatic Measurements

The Oscilloscope offers 18 types of automatic scope measurements. You can display two numeric readings: **measurement 1** and **measurement 2**. These readings are selectable independently, and the measurements can be done on the input waveform.

To choose a average value measurement for **measurement 1**, do the following:

1. Press **MENU** key and the function menu appears on the right side of the screen.
2. Press **MENU ▲** or **MENU ▼** key to select **MEAS SET1**. Five items selectable are visible at the bottom of the screen.
3. Press **F3** key to select **Mean**. The **measurement 1** window shows the average value--**V**.

To choose a Peak-Peak measurement for **measurement 2**, do the following:

1. Press **MENU** key and the function menu is displayed on the right side of the screen.
2. Press **MENU ▲** or **MENU ▼** key and select **MEAS SET2**, with 5 items selectable displayed at the bottom of the screen.
3. Press **F4** key to select **PK-PK**. The **measurement 2** window shows the peak-peak value--**Vp**.

See the following figure 10:

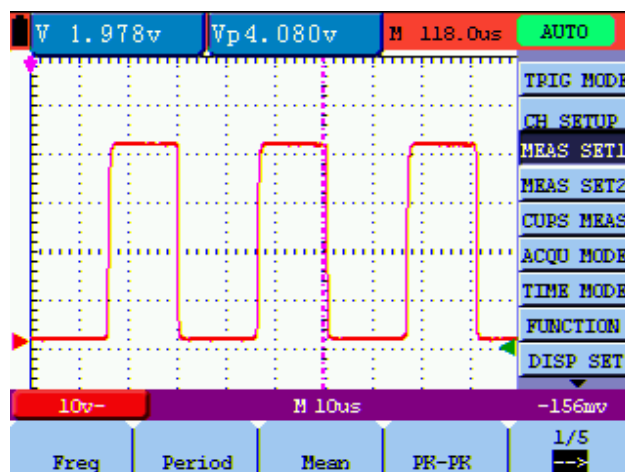

figure 10: Automatic Scope Measurements

6.11 Freezing the Screen

You can freeze the screen (all readings and waveforms)

1. Press the **RUN/STOP** key to freeze the screen and **STOP** appears at top right side of the screen.
2. Press the **RUN/STOP** key once more to resume your measurement.

See the following figure 11:

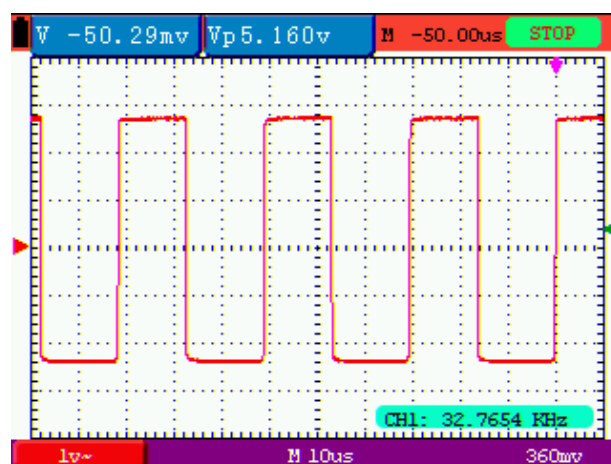

figure 11: Freezing the Screen

6.12 Using Average for Smoothing Waveforms

To smooth the waveform, do the following:

1. Press the **MENU** key and the function menu appears on the right side of the screen.
2. Press **MENU ▲** or **MENU ▼** key to select **ACQU MODE**, with four items selectable

displayed at the bottom of the screen.

3. Press the **F3** key to select **Average**, then, press **F4** key to jump to **Averaging 16** item. This averages the outcomes of **16** acquisitions and shows the final averaging result on the screen, shown as the following figures.

See the following figure 12:

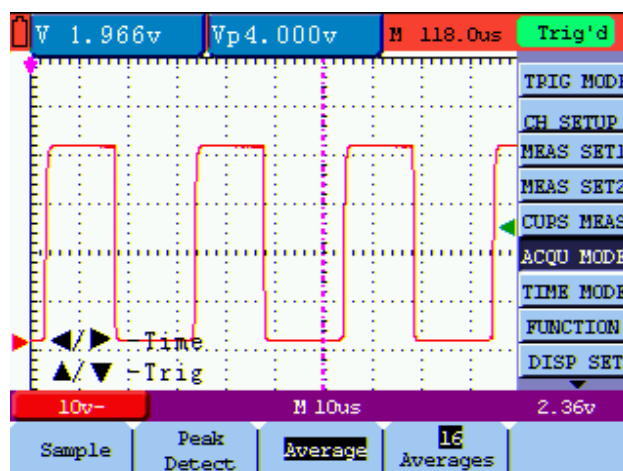

figure 12: Average Factor Sampling Mode

6.13 Using Persistence to Display Waveforms

You can use Persistence to observe dynamic signals.

1. Press **MENU** key and the function menu appears on the right side of the screen.
2. Press **MENU ▲** or **MENU ▼** key to select **DISP SET**. Four items selectable are displayed at the bottom of the screen.
3. Press **F2** key to select **Persist 1 sec, 2 sec, and 5 sec, infinite or close**. In this case, jump to **Infinite** and the observed dynamic is kept on the screen continuously. When the item **Close** is selected, the **Persistence** function is closed.

Look at the display, a screen like the following figure 13 can be shown.

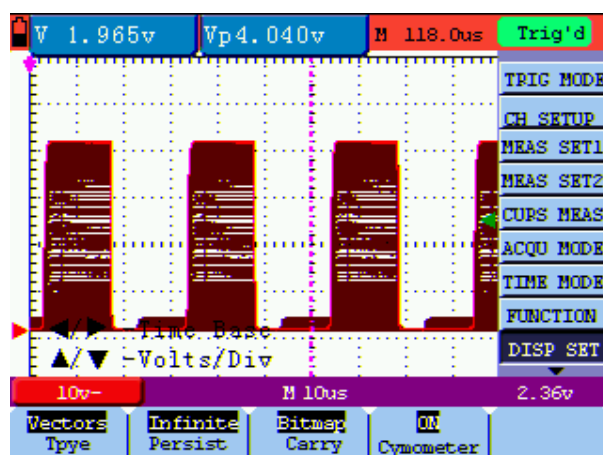

figure 13: Persistence to Observe Dynamic Signals

6.14 Using Peak Detection to Display Glitches

You can use this function to display events (glitches or other asynchronous waveforms) of 50 ns or wider.

1. Press **MENU** key and the function menu appears at the right side of the screen.
2. Press **MENU ▲** or **MENU ▼** key to select the **ACQU MODE**. Four items selectable are displayed at the bottom of the screen.
3. Press **F2** key and jump to Peak Detect. In this case, you can test the glitch.

Now, you can see a screen that looks like the following figure 14.

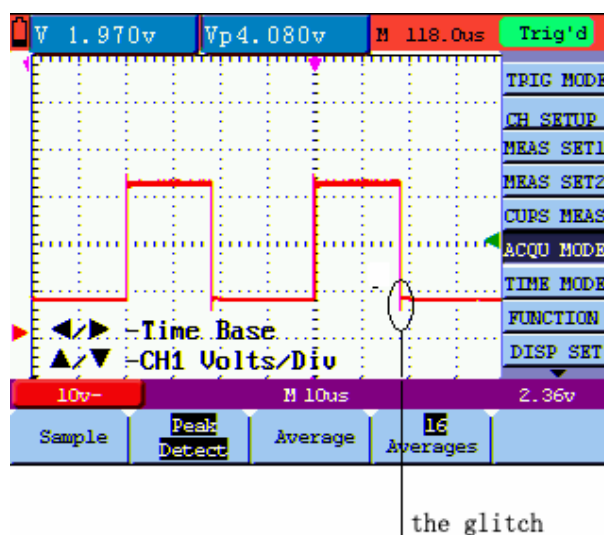

figure 14: Peak Detection

Term interpretation

Collecting mode: The oscilloscope transforms the collected analog data into a digital form after

they are gathered in the following three different modes, such as sampling, peak value detection and averaging values.

Sampling: The oscilloscope takes samples from the signal at a equal time interval to reconstruct the waveform in this mode, by which the analog signal can be expressed correctly in most cases, yet, the rapid changes can not be collected between two sampling time intervals, causing the confusion and loss the narrow pulse in the signal probably.

Peak value detection: The oscilloscope takes samples from the maximum and minimum of signals in each sampling interval and shows the waveform with the sampled data in this mode, thus, by which the oscilloscope may collect the possibly lost narrow pulse in the sampling mode but the noise is obvious.

Averaging values: the oscilloscope collects several waveforms and average over them, and displays the averaged waveform in this mode, by which the random noise can be reduced.

Duration time: When a new waveform is displayed, the previous waveform shown on the screen does not disappear immediately only to be displayed for a period of time, that is, the duration time, by setting which, the waveform can be displayed more continuously and thus a display similar to that shown by the analog oscilloscope can be achieved.

Roll scan mode: The oscilloscope updates the waveform sampling points by scrolling display through a screen from left to right in this mode, which is only applicable to the primary time base setting of above 50ms.

6.15 Selecting AC-coupling

After a reset, the Oscilloscope is dc-coupled so that ac and dc voltages appear on the screen, Use ac-coupling when you wish to observe a small ac signal that rides on a dc signal. To select ac-coupling, do the following:

1. Press **MENU** key and the function menu appears at the right side of the screen.
2. Press **MENU ▲** or **MENU ▼** key to select the **CH SETUP**. Four items selectable are visible at the bottom of the screen.
3. Press the **F1** key and jump to **AC**. The bottom left side of the screen displays the ac-coupling icon.

Now, you can see a screen that looks like the following figure 15.

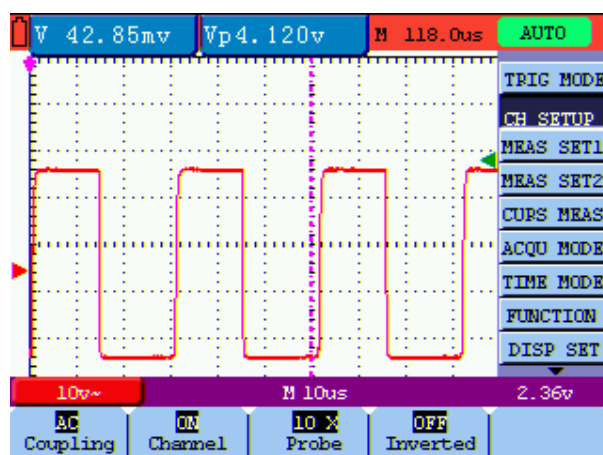

figure 15: AC-Coupling

6.16 Reversing the Polarity of the Displayed Waveform

To invert the input signal waveform, do the following:

1. Press the **MENU** key and the function menu appears at the right side of the screen.
2. Press the **MENU ▲** or **MENU ▼** key to select **CH SETUP**. Four items selectable are displayed at the bottom of the screen.
3. Press **F4** key to jump to **Inverted**. The inverted waveform of the channel is displayed on the screen.

Now, you can see a screen that looks like the following figure 16.

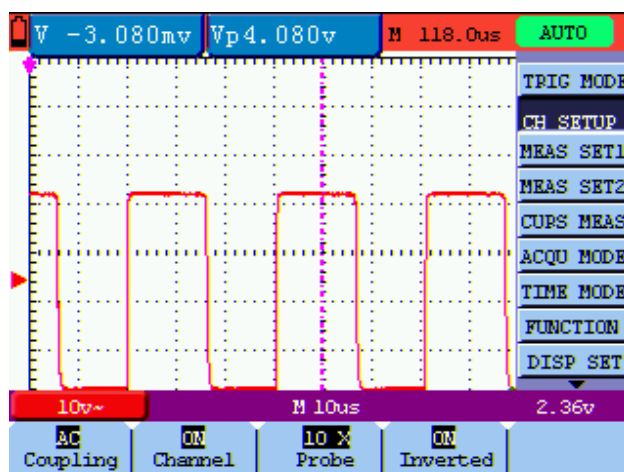

figure 16: Inverted On

7.Using the Multimeter

7.1 About this Chapter

This chapter provides a step-by-step introduction to the multi-meter functions of the test tool hereafter. The introduction gives basic examples to show how to use the menus and perform basic operations.

7.2 Making Meter Connections

Use the three 4-mm safety banana jack inputs for the Meter functions: COM, V/ Ω , mA.

Two quadratic capacitance jacks: CX

See figure 2 for the connections.

7.3 Multimeter Operation Window

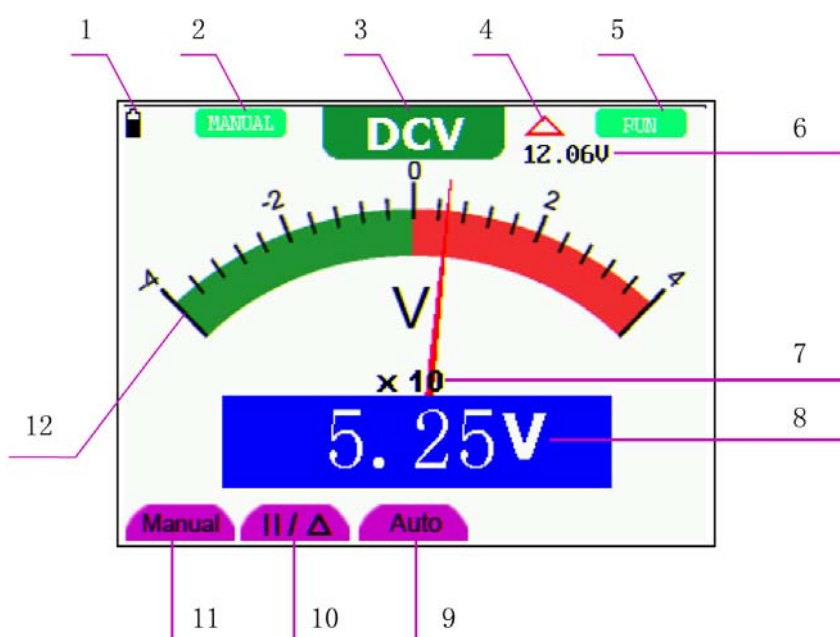

figure 17: Multimeter Operation Window

Description

1. Battery electric quantity indicator.
2. Manual/Auto range indicators, among which the MANUAL means measuring range in manual

operation mode and Auto refers to the measuring range in automatic operation mode.

3. Measurement mode indicators:

DCV: Direct voltage measurement

ACV: Alternating voltage measurement

DCA: Direct current measurement

ACA: Alternating current measurement

R: Resistance measurement

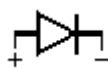

: Diode measurement



: On/Off measurement

C: Capacitance measurement

4. The relative magnitude measurement indicator.
5. Running state indicators, among which RUN expresses continuous update and STOP represents the screen locking.
6. The reference value of the relative magnitude measurement.
7. The multiplying power of the dial indication. To multiply the reading of dial pointer by multiplying power will get the measurement result.
8. The mail reading of measurement
9. Automatic control measuring range.
10. Absolute/ relative magnitude measuring control: The sign “||” expresses the absolute magnitude measuring control and “△” represents the relative magnitude measuring control.
Manually measuring range control.
11. Manual measurement control.
12. Test lead indicated the scale of test reading, different test modes display different colors.

7.4 Making Multimeter Measurements

Press **DMM/OSC** key, the oscilloscope will switch to the multimeter measure, the screen will display the multimeter windows, at the same time, prompt to correctly insert testing pen of the multimeter, at this time, then press any key to enter into multimeter measure.

7.4.1 Measuring Resistance Values

To measure a resistance, do the following:

1. Press the **R** key and **R** appear at the top of the screen.
2. Insert the black lead into the **COM** banana jack input and the red lead into the **V/Ω** banana jack input.
3. Connect the red and black test leads to the resistor. The resistor value readings are shown on the screen in Ohm.

Now, you can see a screen that looks like the following figure 18.

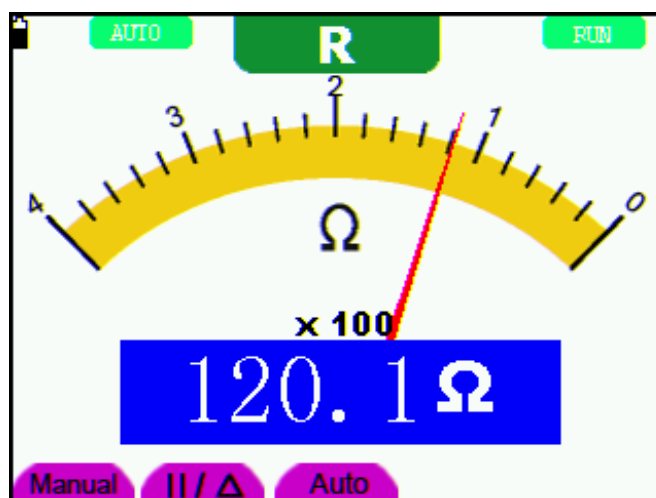
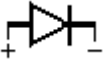

figure 18: Resistance Measurement

7.4.2 Making a Diode Measurement

To make a measurement on the diode, do the following:

1. Press the **R** key and **R** appear at the top of the screen.
2. Press **AUTO SET** key till the following is displayed on the screen 
3. Insert the black lead into the **COM** banana jack input and the red lead into the **V/Ω** banana jack input.
4. Connect the red and black leads to the resistor and the diode resistor readings are displayed on the screen in **V**.

Now, you can see a screen that looks like the following figure 19.



figure 19: Diode Measurement

7.4.3 On-off Test

To perform an On-off test, do the following:

1. Press the **R** key and **R** appears on the top of the screen.
2. Press the **AUTO SET** key till the following is shown on the screen. 
3. Insert the black lead into the **COM** banana jack input and the red lead into the **V/Ω** banana jack input.
4. Connect the red and black leads to the test point. If the resistance value of the tested point is less than $50\ \Omega$, you will hear beep sound from the test tool.

Now, you can see a screen that looks like the following figure 20.

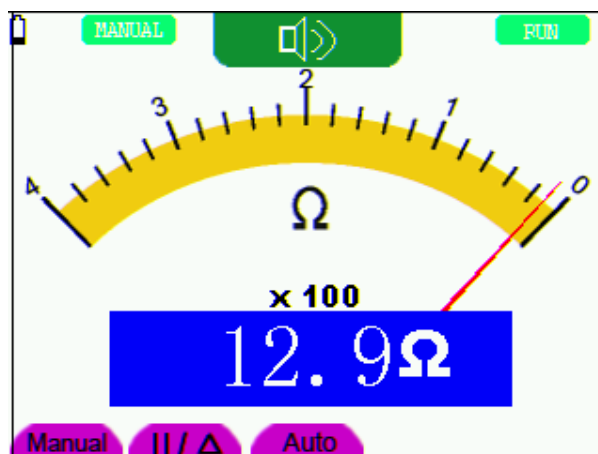

figure 20: On-off Test

7.4.4 Making a Capacitance Measurement

To measure a capacitance, do the following:

1. Press the **R** key and **R** appears on the top of the screen
2. Press the **AUTO SET** key till **C** appears at the top of the screen.
3. Insert the measured capacitance into the quadratic jack and the screen shows the capacitance reading.

Notice: when measured value is less than 5 nF capacitance, please use small capacitance measurer of this multimeter and use relative value measuring mode to improve measuring precision. It will take about 30seconds if capacitance measurement is large than 40uF.

Now, you can see a screen that looks like the following figure 21.

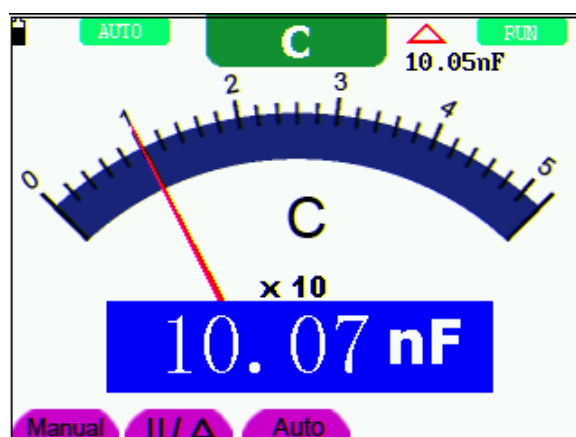

figure 21: Capacitance Measurement

7.4.5 Making a DC Voltage Measurement

To measure a DC voltage, do the following:

1. Press the **V** key and **DCV** appears at the top of the screen.
2. Insert the black lead into the **COM** banana jack input and the red lead into the **V/Ω** banana jack input.
3. Connect the red and black leads to the measured point and the measured point voltage value is displayed on the screen.

Now, you can see a screen that looks like the following figure 22.



figure 22: DC Voltage Measurement

7.4.6 Making a AC Voltage Measurement

To measure the AC voltage, do the following:

1. Press the **V** key and **DCV** appears at the top of the screen.
2. Press the **AUTO SET** key and **ACV** appears at the top of the screen.
3. Insert the black lead into the **COM** banana jack input and the red lead into the **V/Ω** banana jack input.
4. Connect the red and black leads to the measured points and the AC voltage values of measured points will be displayed on the screen.

Look at the display, you can see a screen that looks like the following figure 23.



figure 23: AC Voltage Measurement

7.4.7 Making a DC Current Measurement

To measure a DC current which is less than 400 mA , do the following:

1. Press the **A** key and **DCA** appears at the top of the screen. The unit on the main reading screen is **mA**. **mA** and **20A** will display on the right bottom of screen, press F4 or F5 to switch the measurement between **mA** and **20A**. 400mA is acquiescently.
2. Insert the black lead into the **COM** banana jack input and the red lead into the **mA** banana jack input.
3. Connect the red and black leads to the measured points and the DC current values of measured points will be displayed on the screen.

Look at the display, you can see a screen that looks like the following figure 24.



figure 24: DC Current Measurement for 400 mA

To measure a DC current which is larger than 400 mA, do the following:

1. Press the **A** key and **DCA** appears at the top of the screen. The unit on the main reading screen is **mA**.
2. Press **F5** key change to **20A** measurement, the unit on the main reading screen is **A**.
3. Plug current extended module in current measure jack, then plug the probe in the module
4. Connect the red and black leads to the measured point and the **DC** current value of the measured point will be displayed on the screen.
5. Press F4 return to 400 mA measure.

Look at the display, you can see a screen that looks like the following figure 25.



figure 25: DC Current Measurement for 20A

7.4.8 Making an AC Current Measurement

To measure an AC current which is less than 400 mA, do the following:

1. Press the **A** key and **DCA** appears at the top of the screen. The unit on the main reading screen is **mA**. **mA** and **20A** will display on the right bottom of screen, press **F4** or **F5** to switch the measurement between **mA** and **20A**. 400mA is acquiescently.
2. Press the **AUTO SET** key once and **ACA** is visible at the top of the screen..
3. Insert the black lead into the **COM** banana jack input and the red lead into the **mA** banana jack input.
4. Connect the red and black leads to the measured point and the **AC** current value of the measured point will be displayed on the screen.

Look at the display, you can see a screen that looks like the following figure 26.

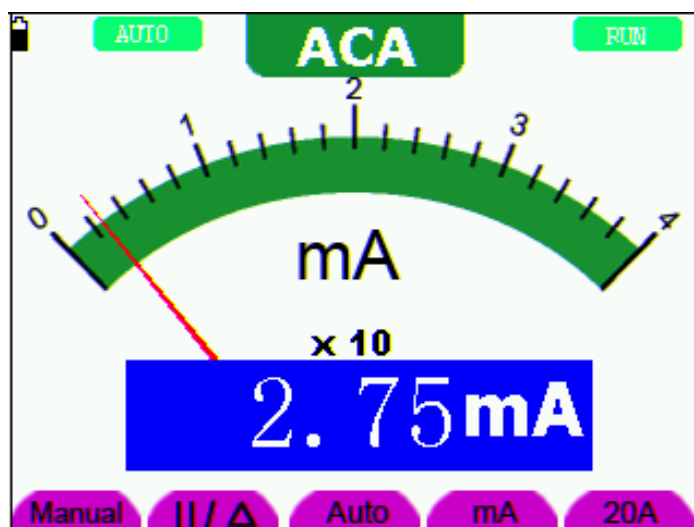

figure 26: AC Current Measurement for 400 mA

To measure an AC current which is larger than 400 mA, do the following:

1. Press the **A** key once and DCA is visible on the top of the screen.
2. Press **F5** to select **20A** measure, the unit of main reading window is **A**.
3. Press the **AUTO SET** key once and ACA is visible on the top of the screen.
4. Plug current extended module in current measure jack, then plug the probe in the module.
5. Connect the red and black leads to the measured point and the **AC** current value of the measured point will be displayed on the screen.
6. Press **F4** return to 400mA measure.

Look at the display, you can see a screen that looks like the following figure 27.



figure 27: AC Current Measurement for 20A

7.5 Freezing the Readings

You can freeze the displayed readings at any time.

1. Press the **RUN /STOP** key to freeze the screen and **STOP** will be displayed at the top right of the screen.
2. Again, press the **RUN /STOP** key, you can resume your measurement.

Look at the display, you can see a screen that looks like the following figure 28.



figure 28: Freezing the Readings

7.6 Taking a Relative Measurement

A currently measured result relative to the defined reference value is displayed in a relative measurement.

The following example shows how to take a relative measurement. At first, it is required to acquire a reference value.

1. Press **R** key and **R** is displayed on the top side of the screen.
2. Press the **AUTO SET** key till **C** appears at the top of the screen.
3. Plug capacitance extended module in capacitance measure jack.
4. When the reading leveling off, press **F2** key and Δ is displayed on the top side of the screen. The saved reference value is displayed below Δ .
5. Plug capacitance, the displayed major reading on the screen is actual the capacitance value.

Look at the display, you can see a screen that looks like the following figure 29.

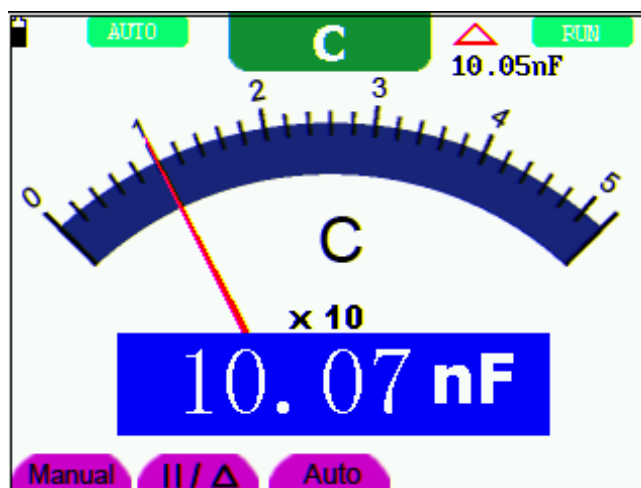

figure 29: Relative Measurement

7.7 Selecting Automatic/Manual Range Adjustment

The defaulted range mode of the instrument is automatic range. To switch to the manual range, perform the following steps:

1. Press **F1** key and **MANUAL** is displayed on the top left side of the screen to enter the manual range mode.
2. Under the manual range mode, the measuring range is increased by a stage when pressing **F1** key each time, and when reaching the highest stage, it jumps to the lowest stage by pressing **F1** key once again. To multiply the reading of dial pointer by multiplying power and the unit of main reading on the screen will get the measurement result.
3. Press **F3** key and **AUTO** is displayed on the top left side of the screen to switch back to the automatic range mode.

Look at the display, you can see a screen that looks like the following figure 30.



figure 30: Automatic/Manual Range Adjustment

Attention: capacitance measurement without manual range mode.

8. Advanced Function of Oscilloscope

8.1 About this Chapter

This chapter will detail the oscilloscope function of the test tool.

8.2 Setting the Channel

Each channel has its own independent vertical menu and each item can be set respectively based on the specific channel.

To make channel settings, do the following:

1. Press the **MENU** key and the function menu appears at the right of the screen.
2. Press the **MENU ▲** or **MENU ▼** key to jump to **CH SETUP** and 4 options appears at the bottom of the screen.
3. Select and press key from **F1** through **F4** keys to make different settings.

Now, you can find a screen that looks like the following figure 31.

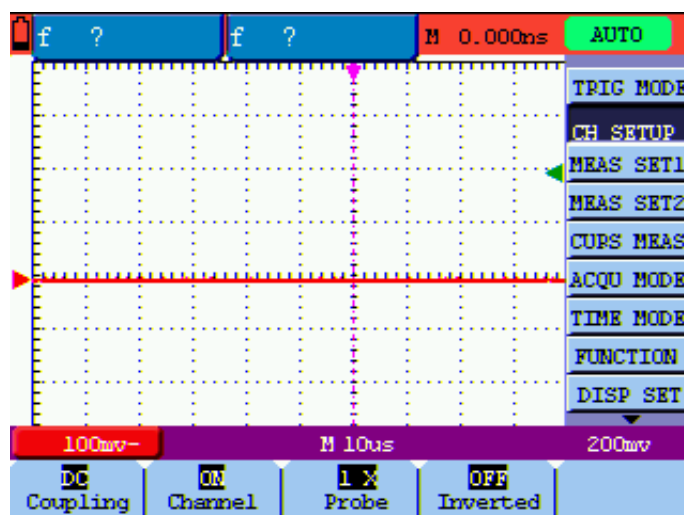

figure 31: Setting the Vertical

The following Table describes the **Vertical Channel** menu:

Function menu	Setting	Description
Coupling	AC	The DC component in the input signal is blocked.
	DC	The AC and DC components of the input signal are allowed.
	Ground	Input signal is interrupted.
Channel	OFF	Close the channel.
	ON	Open the channel.
Probe	1X	Select one according the probe attenuation factor to ensure a correct vertical scale reading.
	10X	
	100X	
	1000X	
Inverted	OFF	Waveform is displayed normally.
	ON	Open the Invert function of the waveform setting.

8.2.1 Setting the Channel Coupling

For example, the measured signal is a square wave signal containing a DC offset. Press **F1 Coupling** first and then **AC** to make an ac coupling setting. The DC component contained in the tested signal is blocked.

Press **F1 Coupling** first and then **DC** to make a DC coupling setting. Both dc and ac components contained in the tested signal are permitted.

Press **F1 Coupling** first and then **Ground** to make a Ground coupling setting. Input signal is interrupted.

The waveform is displayed as the following figure 32, figure 33, figure 34.

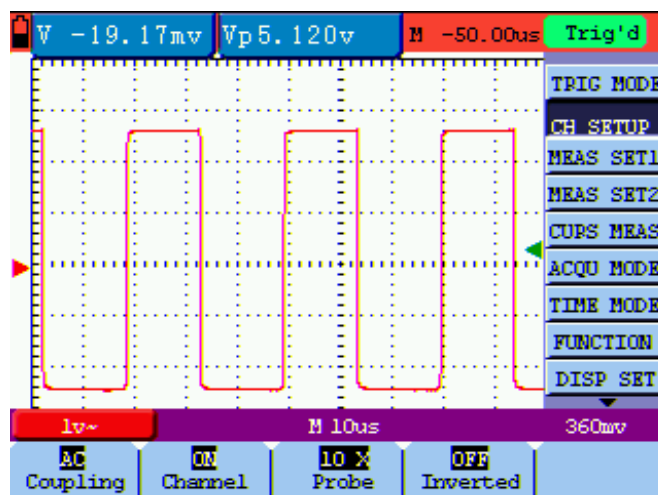

figure 32: AC Coupling

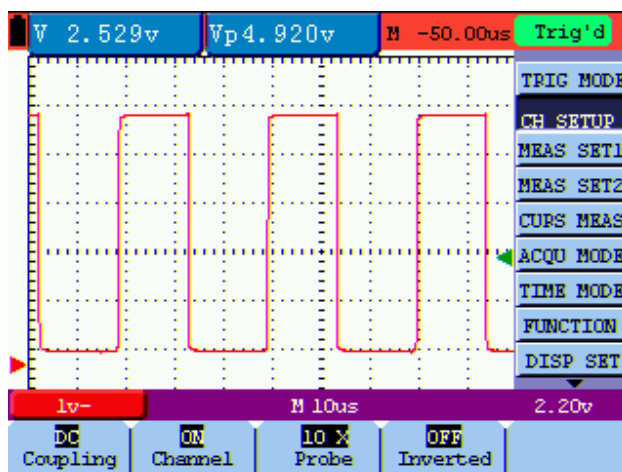

figure 33: DC Coupling

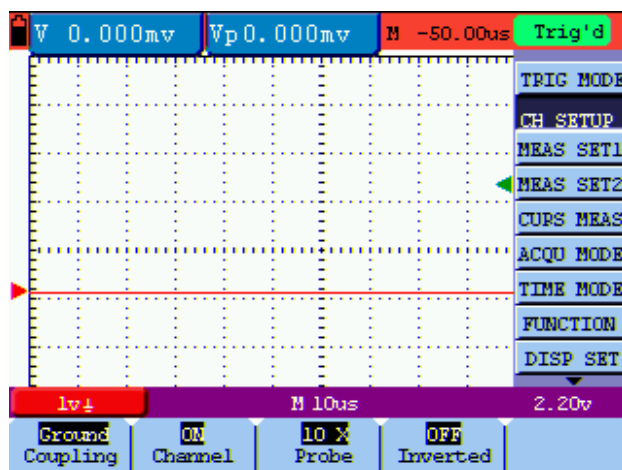

figure 34: Ground Coupling

8.2.2 Make Open and Close Settings on Channel

Press **F2 Channel** key first, then select **OFF** to make a Close setting on channel.

Press **F2 Channel** key first, then select **ON** to make an Open setting on channel.

8.2.3 Adjusting the Probe Scale

It is necessary to adjust the probe attenuation scale factor correspondingly in the channel operation menu in order to comply with the probe attenuation scale. If it is a 10:1 probe, the scale of the input channel of the oscilloscope should be selected as **10X** to avoid any error occurring in the displayed scale factor information and tested data.

Press **F3 Probe** to jump to the relative probe.

Table: Probe attenuation factor and the corresponding menu setting

Probe attenuation factor	Corresponding Menu Setting
1:1	1X
10:1	10X
100:1	100X
1000:1	1000X

8.2.4 Setting of Inverted Waveform

Inverted waveform: The displayed signal reverses 180 degrees relatively to the ground potential.

Press **F4 Inverted** to start Invert; again press **F4 Inverted** to close Invert.

8.3 Setting the Trigger System

The Trigger defines the time when the acquisition of data and display of waveform start. If it is set correctly, the trigger can turn an unstable display into a significant waveform.

When starting the acquisition of data, the oscilloscope collects sufficient data to draw the waveform at the left side of the triggering point. With waiting for the triggering condition, the oscilloscope is gathering data continuously. After a trigger is detected, the oscilloscope gathers enough data continuously to draw the waveform at the right side of the triggering point.

To make a trigger mode setting, do the following:

1. Press the **MENU** key and the function menu appears at the right of the screen.
2. Press the **MENU ▲** or **MENU ▼** key to select **TRIG MODE** and five items selectable are displayed at the bottom of the screen.
3. Select and press one from **F1 through F5** key to make a different setting.
4. Press the **OSC OPTION** key and the following is shown on the screen:

◀/▶ – Time

▲/▼ – Trig

5. Press the **OSC ▲** or **OSC ▼** key to adjust the trigger level position.

Now, look at the display, you can see a screen in the following figure35.

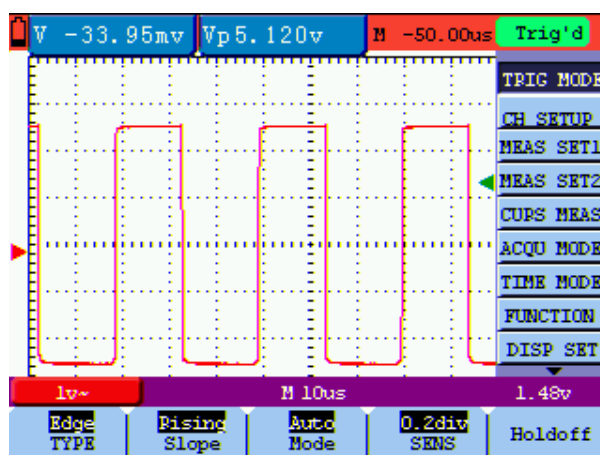

figure 35: Edge Trigger

8.4 Triggering Control

There are two triggering modes including Edge triggering and Video triggering. Each trigger mode is set by different function menu.

Edge triggering: It occurs when the trigger input passes through a given level along the specified direction.

Video triggering: Perform video field trigger , line trigger, odd field trigger, even field trigger or line NO. trigger on the standard video signals.

The following describes the Edge triggering and Video triggering menus respectively.

8.4.1 Edge Triggering

The Edge triggering is a mode by which trigger occurs at the triggering threshold value of the input signal edge. With the **Edge triggering** selected, the trigger happens on the rise or fall edge of the input signal, shown as figure 35.

The **Edge triggering** menu is described in the following table.

Function menu	Settings	Description
Slope	Rising	Triggering on the rise edge of the signal.
	Falling	Triggering on the fall edge of the signal.
Mode	Auto	Acquisition of waveforms is possible even if there is no triggering condition detected.
	Normal	Acquisition of waveforms can only be done when the triggering condition is satisfied.
	Single	The sampling is performed on a waveform when one trigger is detected, then stop sampling.
Sens	0.2~1.0div	Set trigger sensitivity.
Holdoff		To go to holdoff menu

8.4.2 Video Triggering

With **Video triggering** selected, the oscilloscope performs the NTSC, PAL or SECAM standard video signals field , line ,odd field,even field or line num trigger.

Figure 36 is the Video Line Trigger, figure 37,figure 38 is the Video Line trigger.

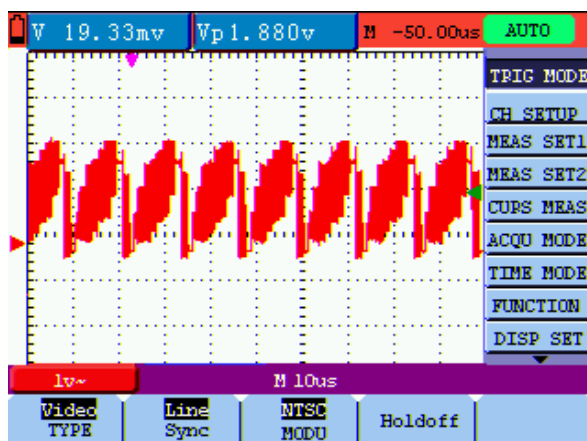

figure 36: Video Line Trigger

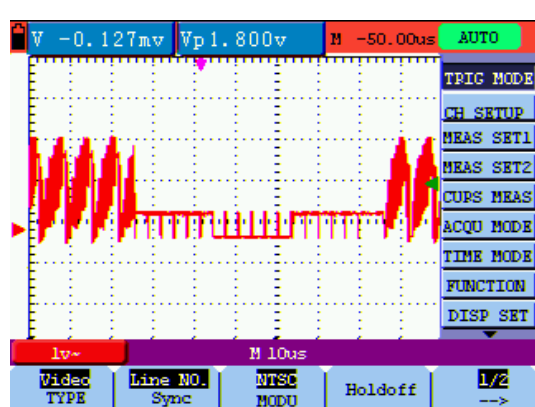

figure 37: Video Line NO. trigger(Page1)

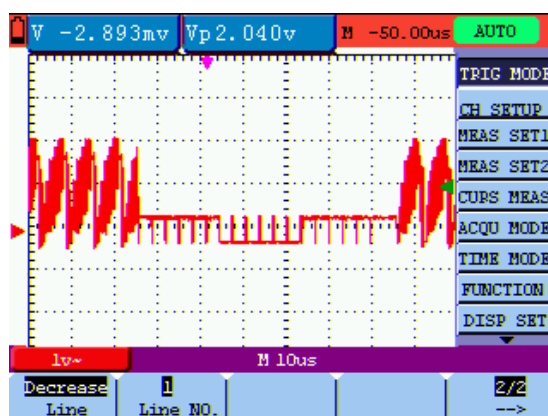



figure 38: Video Line NO. trigger(Page2)

when the sync is Line,Field,Odd Field,Even Field,the menu is shown as bellow.

Function menu	Settings	Description
Sync	Line Field Odd Field Even Field	Make a video line trigger synchronization setting. Make a video field trigger synchronization setting. Make a video odd field trigger synchronization setting. Make a video even field trigger synchronization setting.
MODU	NTSC PAL/SECAM	Video format setting
Holdoff		Go to the holdoff menu.

when the sync is Designed Line,the menu is shown as bellow.

Function menu	Settings	Description
Sync	Designed Line	Make a video designed line synchronization setting.
MODU	NTSC PAL/SECAM	Video format setting
Holdoff		Go to the holdoff menu.
		Go to the next menu.
Line	increase	Set the line value to increase.
	decrease	Set the line value to decrease.
Line No.		Set and Show the line valve.
		Back up to previous menu.

When you go to the holdoff menu, you can see a screen in the following figure39.

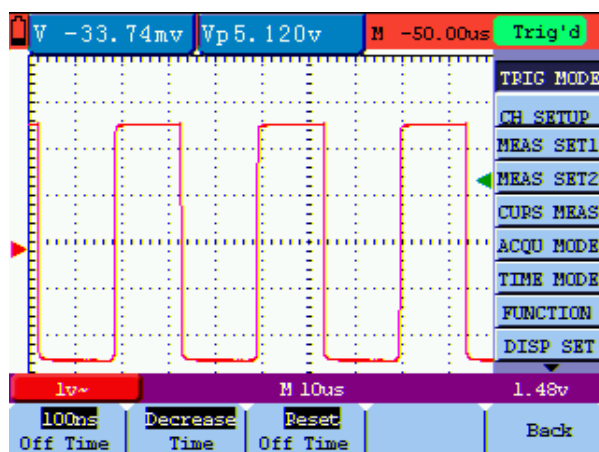

Figure39:Trigger Holdoff

the **Holdoff** menu is described in the following table:

Function menu	Settings	Description
Off Time	100ns~10s	Set time slot before another trigger event.
Time	increase	Set the off time to increase.
	decrease	Set the off time to decrease.
Reset Off Time		Reset Holdoff time to 100ns.
Back		Back up to previous menu.

Note:

Trigger Holdoff can stabilize complex waveform, such as the pulse range. Holdoff time is the oscilloscope's waiting period before starting a new trigger. During Holdoff, the oscilloscope will not

trigger until Holdoff ends.

Term interpretation

Trigger modes: There are three kinds of trigger modes available for this oscilloscope, they are auto, normal and single shot.

Automatic trigger mode: The oscilloscope can acquire the waveform without any triggering condition detected in this mode, in which it will be triggered compulsively when waiting for a specified period of time without any triggering condition ignited. When an invalid trigger is enforced, the oscilloscope can not keep the waveform in phase.

Normal trigger mode: In this mode, the oscilloscope cannot acquire the waveform till it is triggered. When there is not any trigger, the oscilloscope will display the origin waveform without new waveforms captured.

Single shot mode: In this mode, the oscilloscope will detect a trigger and capture a waveform at each time when the customer presses the RUN/STOP key.

Holdoff: Set time slot before another trigger event.

8.5 Acquiring Mode Setting

The **Acquiring Mode** menu is described in the list shown as below.

Function menu	Settings	Description
Sample		Normal sampling mode.
Peak Detect		Used to detect the jamming glitch and reduce the possible blurring.
Average		Used to reduce the random and unrelated noises. Several average factors are available for being selected.
Averages	4, 16, 64 or 128	Select the average factor.

8.6 Display Setting

The **DISP SET** menu is described in the following table.

Function menu	Settings	Description
Type	Vectors	The vector is filled up spaces between neighboring sampling points in the display.
	Dots	Only sampling points are displayed.
Persist	OFF 1s 2s 5s Infinite	Setting persistence time for each sampling point.

Carry	Bitmap Vectors	The data transmitted in communication are bitmaps. The data transmitted in communication are vectors.
Cymometer	ON OFF	Turn on the Cymometer. Turn off he Cymometer.

8.6.1 Display Style

The display style includes **Vector** and **Dot** displays, shown as the following figure 40, figure 41.

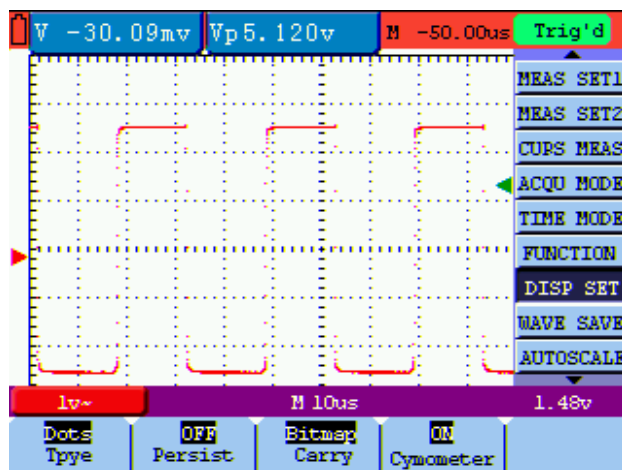

figure 40: Dot Style

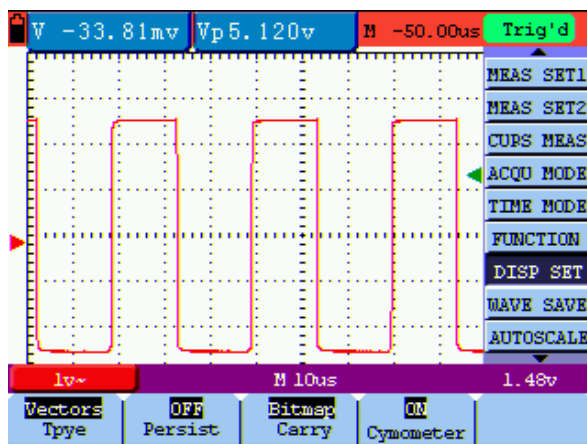

figure 41: Vectors Style

8.6.2 Persistence

With **Persistence** function selected, the displayed saved original data gradually decay in color and the new data are bright in color; with infinite persistence mode selected, the recorded points will be kept on the screen till the controlled value is changed.

8.6.3 Cymometer

It is a 6 digits cymometer. Its measurement range of frequency is 2Hz to full bandwidth. It can only measure the frequency of the triggering channel.

To make a cymometer setting, do the following:

1. Press **MENU**, the function menu will appear on the right of the screen.
2. Press **MENU ▲** or **MENU ▼** and select **DISP SET**, four options will show at the bottom of the screen.
3. Press **F4** and select **Cymometer** to ON, then the frequency of the signal will display at the right corner of the screen.

See the following figure 42:

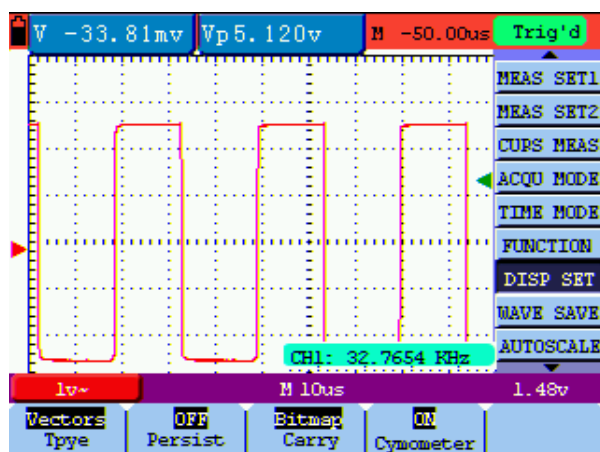

Figure 42:

8.7 Waveform Saving Setups

The oscilloscope can save 4 waveforms, which can be displayed on the screen with the present waveform. The recalled waveform saved in the memory cannot be adjusted.

The **waveform saving /recalling menu** is described in the following list.

Function menu	Set up	Description
WAVE	A, B, C and D	Select the address for saving or recalling a waveform.
Save		Store the waveform into the selected address.
Show	ON OFF	Close or start displaying the waveforms stored in address A, B, C or D.

To save a waveform in address A, do the following:

1. Press the **MENU** key and the function menu appears at the right of the screen.

2. Press the **MENU ▲** or **MENU ▼** key to select the **WAVE SAVE**. Four items selectable are displayed at the bottom of the screen.
3. Press the **F1** key to select the address A.
4. Press the **F2** key to save the waveform in address A.

To display the saved waveform on the screen, do the following:

5. Press the **F3** key to select **ON** and the waveform saved in address A will be displayed on the screen in green color.

The display color is green, and the zero point of waveform , voltage and time is purple.

Now, you can see a screen that looks like the following figure 43.

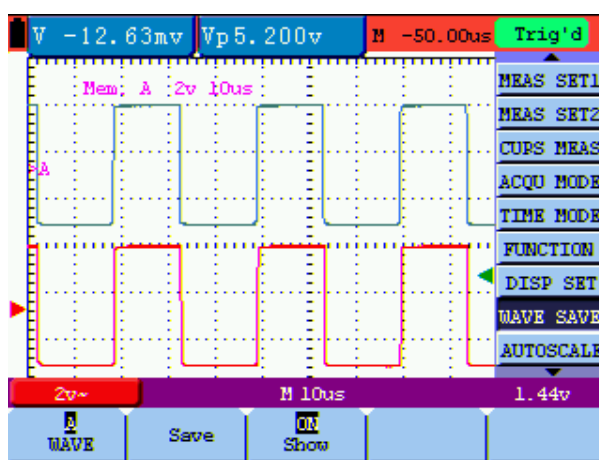

figure 43: Waveform Saving

8.8 Function Setting Menu

The **function setting** menu is described in the following list.

Function menu	Setting	Description
Recall Factory		Resume the instrument to its factory settings.
Auto Cailibration		Perform the Auto-calibration procedure.
Language	Chinese English	Select the display language of the operation system.

Self-correcting:

The self-correcting program can improve the accuracy of the oscilloscope under the ambient temperature to the maximum. If the ambient temperature variation is equal to or larger than 5 Celsius degrees, the self-correcting program should be performed to gain the maximum accuracy.

Before the self-correcting program is performed, the probe or lead should be disconnected with the input connector, then, select the **F2** key **Self-correcting** item. After confirming that everything is ready, press the **F2** key “**Self-correcting**” key and enter into the self-correcting program.

8.9 Making Automatic Measurements

The oscilloscope can perform 18 types automatic measurements such as frequency, cycle, average value, peak-to-peak value, root mean square value, V_{max} , V_{min} , V_{top} , V_{base} , V_{amp} , Overshoot, Preshoot, RiseTime, Fall Time, +Width, -Width, +Duty, -Duty. And gives two kinds of measurement results simultaneously on the screen.

The function menu for automatic measurements is described in the following list.

Function menu	Description
Freq	Measure the frequency of the signal.
Period	Measure the Period of the signal.
Mean	Measure the average value of the signal.
Peak-Peak	Measure the peak-to-peak value of the signal.
Cyc RMS	Measure root mean square (RMS) value of the signal.
V_{max}	Measure the V_{max} of the signal.
V_{min}	Measure the V_{min} of the signal.
V_{top}	Measure the V_{top} of the signal.
V_{base}	Measure the V_{base} of the signal.
V_{amp}	Measure the V_{amp} of the signal.
Overshoot	Measure the Overshoot of the signal.
Preshoot	Measure the Preshoot of the signal.
RiseTime	Measure the RiseTime of the signal.
Fall Time	Measure the Fall Time of the signal.
+Width	Measure the +Width of the signal.
-Width	Measure the -Width of the signal.
+Duty	Measure the +Duty of the signal.
-Duty	Measure the -Duty of the signal.

To measure the average value with **Measurement 1** and the peak-to-peak value with **Measurement 2**, do the following:

1. Press the **MENU** key and the function menu is shown at the right of the screen.
2. Press the **MENU ▲** or **MENU ▼** key to select **MEAS SET1**. Five options appear at the bottom of the screen.
3. Press the **F3** key to select **Mean**. The measurement window 1 on the screen shows the frequency.
4. Press the **MENU ▲** or **MENU ▼** key to select **MEAS SET 2**. Five options appear at the bottom of the screen.
5. Press the **F4** key to jump to the **PK-PK** measurement. The measurement window 2 on the screen shows the peak-to-peak value.

Now, you can see a screen that looks like the following figure 44.

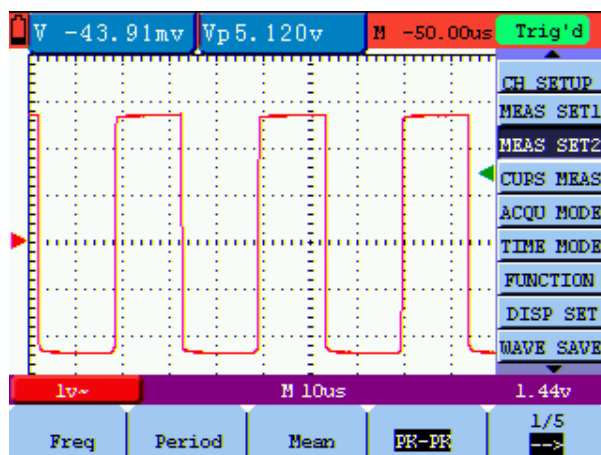

figure 44: Automatic Measurements

Term interpretation

Vpp: Peak-to-Peak Voltage.

Vmax: The maximum amplitude. The most positive peak voltage measured over the entire waveform.

Vmin: The minimum amplitude. The most negative peak voltage measured over the entire waveform.

Vamp: Voltage between Vtop and Vbase of a waveform

Vtop: Voltage of the waveform's flat top, useful for square/pulse waveforms.

Vbase: Voltage of the waveform's flat base, useful for square/pulse waveforms.

Overshoot: Defined as $(V_{max} - V_{top}) / V_{amp}$, useful for square and pulse waveforms.

Preshoot: Defined as $(V_{min} - V_{base}) / V_{amp}$, useful for square and pulse waveforms.

Average: The arithmetic mean over the entire waveform.

Vrms: The true Root Mean Square voltage over the entire waveform.

Rise Time: Time that the leading edge of the first pulse in the waveform takes to rise from 10% to 90% of its amplitude.

Fall Time: Time that the falling edge of the first pulse in the waveform takes to fall from 90% to 10% of its amplitude.

+Width: The width of the first positive pulse in 50% amplitude points.

-Width: The width of the first negative pulse in the 50% amplitude points.

+Duty: +Duty Cycle, defined as $+Width / Period$

-Duty: -Duty Cycle, defined as $-Width / Period$.

8.10 Setting the Cursor Measurements

This oscilloscope allows you to make manual cursor measurements on time and voltage..

The cursor measurement menus are listed and described in the following table.

Function menus	Settings	Description
Type	OFF Voltage Time	Close the cursor measurement. Display the voltage measurement cursor and menu. Display the time measurement cursor and menu.
Delta		Display the difference of measured value between the two cursors.
Cur1		Display the relating measured value of Cursor 1.
Cur2		Display the relating measured value of Cursor 2.

To make a voltage measurement, doing the following:

1. Press the **MENU** key and the function menus are displayed at the right of the screen.
2. Press the **MENU ▲** or **MENU ▼** key to select **CURS MEAS**. Four options are shown at the bottom of the screen.
3. Press F1 key to select the measurement type Voltage. Two purple crossing dashed lines V1 and V2 are shown on the screen.
4. Press and hold the **OSC OPTION** key till the **▲/▼ CURSOR V1** is visible on the screen. At this time, adjust **OSC ▲** or **OSC ▼** and you can see that the dashed line **V1** is moving up and down while the measured voltage value of **V1** relative to the zero position of the channel appears on the Curs1 item at the bottom of the screen.
5. Press and hold the **OSC OPTION** key till **▲/▼ CURSOR V2** appears on the screen. Now, adjust the **OSC ▲** or **OSC ▼** and you can observe the dashed line **V2** moving **▲** and **▼** while the measured voltage value of **V2** relative to the zero position of the channel is displayed on the Curs2 item at the bottom of the screen. Also, the absolute values of **V1** and **V2** can be shown on the Delta item at the bottom of the screen.

Now, you can see a screen that looks like the following figure 45.

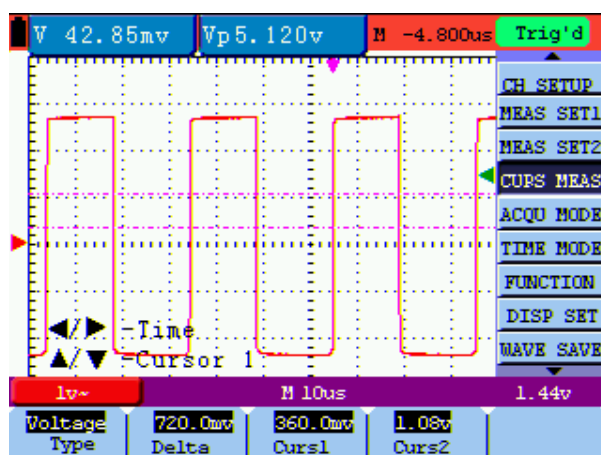

figure 45: Use the Cursor for a Voltage Measurement

To use the cursor for a time measurement, do the following:

1. Press the **MENU** key and the function menus are displayed at the right of the screen.
2. Press the **MENU ▲** or **MENU ▼** key to select **CURS MEAS** key. Four key labels selectable are shown at the bottom of the screen.
3. Press the **F1** key to the measurement type **Time**. Two vertical dashed lines T1 and T2 appear on the screen.
4. Press and hold the **OSC OPTION** key till the **▲/▼ CURSOR 1** appears on the screen. Then, adjust the **OSC ▲** or **OSC ▼** and you can observe the dashed line moving left and right. At the same time, the time value of **T1** relative to the screen middle point position will be displayed on the Curs1 item at the bottom of the screen.
5. Keep pressing on the **OSC OPTION** key till the **▲/▼ CURSOR 2** is displayed on the screen. Then, adjust the **OSC ▲** or **OSC ▼** and you can find that the dashed line **T2** is moving right and left while the time value of **T1** relative to the screen middle point position appears on the Curs2 item at the bottom of the screen. You can also observe the absolute time values of **T1** and **T2** on the Delta item at the bottom of the screen..

Now, you can see a screen that looks like the following figure 46.

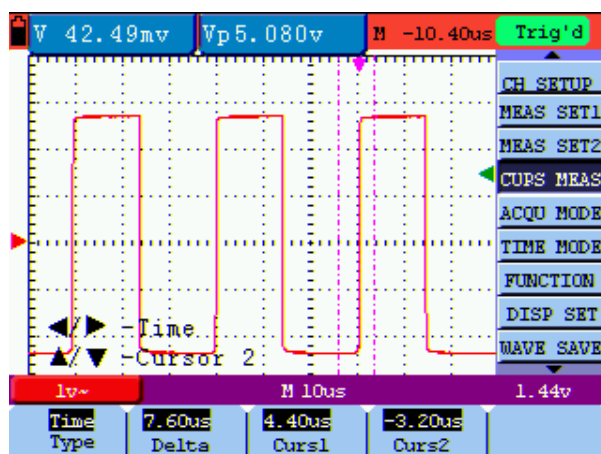



figure 46: Use the Cursor for a Time Measurement

8.11 Autoscale

The function is applied to follow-up signals automatically even if the signals change at any time. Autoscale enables the instrument to set up trigger mode, voltage division and time scale automatically according to the type, amplitude and frequency of the signals.

The menu is as follows:

Function Menu	Setting	Instruction
Autoscale	OFF	Turn off Autoscale.
	ON	Turn on Autoscale.
Mode	Vertical	Follow-up and adjust vertical scale without changing horizontal setting.
	Horizontal	Follow-up and adjust horizontal scale without changing vertical setting.
	HORI—VERT	Follow-up and adjust the vertical and horizontal settings.
		Only show one or two periods.
		Show Multi-period waveforms.

If you want to measure voltage , you can do as the follows:

1. Press **MENU**, the function menu will appear on the right of the screen.
2. Press **MENU ▲** or **MENU ▼** and choose **Autoscale**, three options will show at the bottom of the screen.
3. Press **F1** and choose **ON**.
4. Press **F2** and choose **HORI-VERT**.
5. Press **F3** and choose .

Now, you can see a screen that looks like the following figure 47.

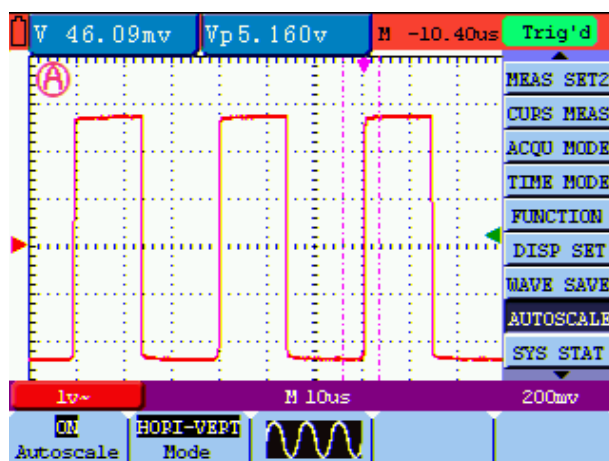

figure 47: Autoscale Horizontal- Vertical multi-period waveforms

Note:

1. Entering into Autoscale function and A flicker will be on the top left corner. (flicker every 0.5 second)
2. At the mode of Autoscale, the oscilloscope can self-estimate “Trigger mode” (Edge, Video). If now, you press “Trigger mode”, the forbidden information will display on the screen.
3. At the mode of Autoscale, DSO is always in the state of DC coupling and AUTO triggering. In this case, the forbidden information will be showing when making Triggering or Coupling settings.
4. At the mode of Autoscale, if adjust the vertical position, voltage division, trigger level or time scale of the waveform, the oscilloscope will turn off Autoscale function and if press “AUTOSET” key again, the oscilloscope will enter into Autoscale.
5. Turn off the submenu at the Autoscale menu, the Autoscale is off and turn on the submenu still enters into the function.
6. When video triggering, the horizontal time scale is 50us. If one channel is showing edge signal, the other channel is showing video one, the time scale refers to 50us as video one as standard.
7. While the Autoscale is working, below settings will be made forcibly:
 - (1) The unit will switch from non-main time base to main time base status.
 - (2) The unit will switch to Peak detection menu while in the state of Average sampling mode.

8.12 System State Menu

The system state menu is used to display information about the present horizontal system, vertical system, trigger system and others. The operation steps are shown as below.

1. Press the **MENU** key and the function menu is displayed at the right of the screen.
2. Press the **MENU ▲** or **MENU ▼** key to select the **SYS STAT**. Four options appear at the bottom of the screen.
3. Sequentially press key **F1** through **F4** key and the corresponding state information will be shown on the screen.

The screen that looks like the following figure 48 will be displayed.

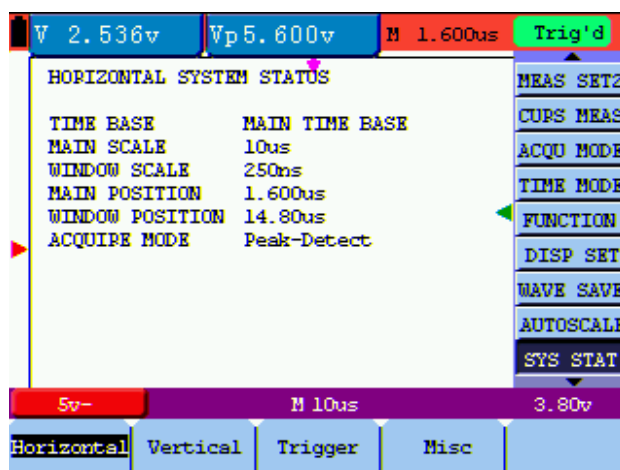

figure 48: System State

8.13 Setting of Time Base Mode

The time base mode menu is explained as the following table.

Function menu	Setting	Explanation
TimeBase	Main	Horizontal main time base is used to wave display.
Window	Zone	Use two cursors to define a window area.
Window		Expand the defined window to full-screen display.

For the operation of window extension, please execute the following steps:

1. Press **MENU** key, display the function menu on the right side of the screen.
2. Press **MENU ▲** or **MENU ▼** key to select **TIME BASE**, display three options at the bottom.
3. Press **F2** key to select window setting.

4. Press **OSC OPTION** key, pop up **TIME BASE**, at this time, then press **OSC ◀** and **OSC ▶** key to adjust the time base window area defined by two cursors, the window size will vary.
5. Press **OSC OPTION** key and call **TIME**, at this time, press **OSC ◀** and **OSC ▶** to adjust the window position defined by two cursors, the window position is the time difference of the window center to main time base's horizontal pointer.
6. Press **F3** key, select window extension, the defined window extends into the full-screen display.

The screen that looks like the following figure 49, 50 will be displayed.

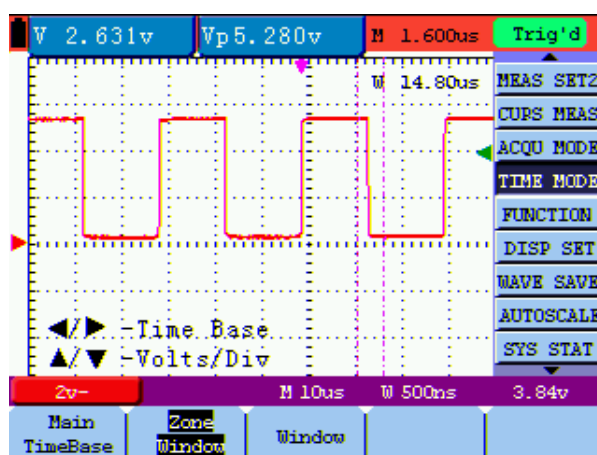

figure 49: Window Setting

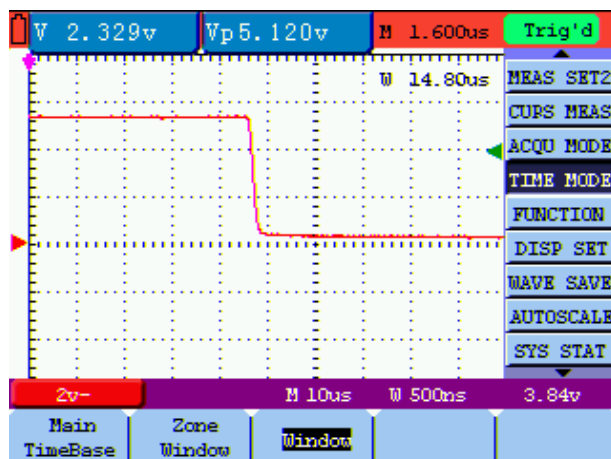

figure 50: Window Extension

8.14 Data Transmission

For the operation of data transmission, please execute the following steps:

1. Press **MENU** key, display the function menu on the right side of the screen.
2. Press **MENU ▲** or **MENU ▼** key to select display setting mode, display four options at the bottom.

3. Press **F4** key, and select the **Bitmap** or **Vectors** for data transmission.
4. Use a data line to connect the oscilloscope and the PC .
5. Open the OWON software that had been installed completely.
6. Setting the parameter under the use's manual, and then starts data transmission.

9. Trouble Shooting

1. The oscilloscope does not power up.

It may be caused by the dead battery. At this time, the oscilloscope will not start even if it is powered by the battery charger. Firstly, charge the battery and supply the oscilloscope with power through the battery charger. However, don't switch on the oscilloscope till waiting for 15 minutes. If the oscilloscope still cannot start, please contact OWON for service.

2. The oscilloscope stops working only after operating for several seconds.

Probably the battery is dead; Check the battery symbol at the upper right of the screen. The  symbol indicates that the battery has been run out of power and must be charged.

3. The measurement type displays ERR when you switch to the Multimeter mode.

Probably you do not select the measuring mode. In this case, push down any key of the three keys V, A or R. Thus, the relative measuring mode will be shown on the screen. If the ERR is still displayed, restart the oscilloscope.

4. The measured voltage amplitude value is 10 times larger or smaller than the real value under the oscilloscope mode.

Check whether the channel attenuation level matches the actual probe attenuation ratio.

5. The waveform is displayed on the screen but is not stable under the oscilloscope mode.

Check on the trigger mode: The edge trigger mode is applicable to the universal single and the video trigger mode applicable to the video signal. Only when the proper trigger mode is applied, can the waveform be in stable.

6. There is no display on the screen when you push down RUN/STOP key under the oscilloscope mode.

Check whether the trigger mode in the trigger mode menu is in normal or single shot and whether the trigger level is out of the waveform range.

In such condition, adjust and make the trigger level in the middle or select the non-auto trigger mode. Additionally, press the AUTO SET key and complete the above setting

7. When select the average sampling in the sampling mode or select a longer display time in the display mode under the oscilloscope, the display speed is slow.

It is normal in the above case.

10.Appendix

10.1 Appendix A: Specifications

10.1.1 Oscilloscope

Only if another instructions are provided, are all technical specifications applicable to the probe with the 10X attenuation switch setting and the HDS1021M digital oscilloscope. In order to be up to these specifications, the oscilloscope should meet the following requirement.

- The instrument should operate continuously for more than 30 minutes under the specified operating temperature.
- If the operating temperature range of variation is up to or larger than 5 Celsius degrees, the system function menu must be opened to make the system perform a “self- calibration” procedure.

Except those specifications marked with the word **Typical**, all specifications can be up to.

Sampling

Sampling modes	Normal sampling Peak detection Average value
Sampling rate	100 MSa/s

Input

Input coupling	DC, AC, Groud
Input impedance	1M Ω \pm 2% connected in parallel with 18pF \pm 5pF
Probe attenuation coefficient	1X, 10X, 100X, 1000X
Max. Input voltage	400V (peak)

Horizontal

Sampling rate range	0.25S/s~100MS/s
Waveform interpolation	(sin x) /x
Record length	6K points
Scanning speed range (S/div)	5ns/div~100s/div, stepping in the “1-2.5-5” mode.
Time interval (Δ T)measurement accuracy (full bandwidth)	Single: \pm (1 sampling interval time+100ppm \times reading+0.6ns) >average 16 : \pm (1 sampling interval time +100ppm \times reading+0.4ns)

Vertical

Analog digital converter (A/D)	the resolution of 8 bits
Sensitivity range (V/div)	5mV/div~5V/div (at the input BNC)
Displacement range	$\pm 10\text{div}(5\text{mV/div}\sim 2\text{V/div})$, $\pm 6\text{div}(5\text{V/div})$
Analog bandwidth	20M
Single bandwidth	Full bandwidth
Low frequency response (AD coupling, -3dB)	$\geq 5\text{Hz}$ (at the BNC)
Rise time (typical one at the BNC)	$\leq 17.5\text{ns}$
DC gain accuracy	$\pm 3\%$
DC measurement accuracy (average value sampling mode)	The voltage difference (ΔV) between any two points on the waveform after averaging the captured waveforms more than 16: $\pm(5\% \text{ reading} + 0.05 \text{ divisions})$.

Trigger

Trigger sensitivity (Edge triggering)	Ajustable:0.2~1div(DC ~ full bandwidth)
Triggering lever range	± 4 divisions from the screen center
Triggering level accuracy (typical) which is applicable to the signal with rise and fall time equal to or longer than 20ns	± 0.3 divisions
Trigger displacement	655 divisions for pre-triggering and 4 divisions for post-triggering
Trigger Holdoff range	100ns~10s
Make a 50% level setting (Typical).	Operation with the input signal frequency equal to or larger than 50Hz.
Trigger sensitivity (Video triggering and typical mode)	2 divisions of peak-to-peak value
Signal system and line/field frequency (Video triggering mode)	Support the NTSC, PAL and SECAM broadcasting systems of any field or line frequency.
Cymometer	
Readout resolution	6 digits
Frequency range	AC coupling, 2Hz to full bandwidth

Measurement

Cursor measurement	Voltage difference (ΔV) and time difference (ΔT) between cursors
Auto measurement	Peak-to-peak value, average value, root mean square value, frequency, period, Vmax, Vmin, Vtop, Vbase, Vamp, Overshoot, Preshoot, RiseTime, Fall Time, +Width, -Width, +Duty, -Duty.

Probe

	1X position	10X position
Bandwidth	Up to 6 MHz (DC)	Up to full bandwidth (DC)
Attenuation rate	1: 1	10: 1
Compensation range	15pf~35pf	
Input resistance	1M Ω \pm 2%	10M Ω \pm 2%
Input impedance	85pf~115pf	14.5pf~17.5pf
Input voltage	<200 V DC+Peak AC	<600 V DC+Peak AC

10.1.2 Meter**Voltage (VDC)**

Input Impedance: 10M Ω .

Max. Input Voltage: 1000V (DC or AC peak-to-peak value)

Range	Accuracy	Resolution
400.0mv	\pm 1% \pm 2 digit	100uV
4.000V		1mV
40.00V		10mV
400.0V		100mV
1000.0V		1V

Voltage (VAC)

Input Impedance: 10M Ω .

Max. Input Voltage: 750V(AC, virtual value)

Frequency range: from 40Hz to 400Hz.

Display: Virtual value of the sine wave

Range	Accuracy	Resolution
4.000V	\pm 1% \pm 3 digits	1mV
40.00V		10mV
400.0V		100mV
750.0V	\pm 1.5% \pm 3 digits	1V

Direct Current (DC)

Range	Accuracy	Resolution
40.00mA	\pm 1% \pm 1 digit	10uA
400.0mA	\pm 1.5% \pm 1 digit	100uA
20A	\pm 3% \pm 3字	10mA

Alternating Current (AC)

Range	Accuracy	Resolution
40.00mA	$\pm 1.5\% \pm 3$ digit	10uA
400.0mA	$\pm 2\% \pm 1$ digit	100uA
20A	$\pm 5\% \pm 3$ 字	10mA

Resistance

Range	Accuracy	Resolution
400.0 Ω	$\pm 1\% \pm 3$ digits	0.1 Ω
4.000K Ω	$\pm 1\% \pm 1$ digit	1 Ω
40.00K Ω		10 Ω
400.0K Ω		100 Ω
4.000M Ω		1K Ω
40.00M Ω	$\pm 1.5\% \pm 3$ digit	10K Ω

Capacitance

Range	Accuracy	Resolution
51.20nF	$\pm 3\% \pm 3$ digits	10pF
512.0nF		100pF
5.120uF		1nF
51.20uF		10nF
100uF		100nF

Diode

Voltage reading: 0 V \sim 1.5 V.

On-off Test

You can a beep sound when the on-resistance is less than 50 Ω .

10.1.3 General Specifications**Basic parameter**

Mechanical dimension	18 cm \times 11.5cm \times 4cm
Weight	455 g
Power consumption	< 3 W
Display type	3.5" color liquid crystal display
Display resolution	320 (horizontal) \times 240 (vertical) pixels
Display color	65536 colors

Power Adapter

Power supply	100-240 V AC 50/60Hz
Power output	8.5 VDC
Current output	1500 mA

Battery:7.4V built-in Li-ion Battery

Working environment

Temperature

Operation

Used battery 0 to 50 °C(32 to 122 °F)

Power adapter 0 to 40 °C(32 to 104 °F)

Storage. -20 to +60 °C(-4 to +140 °F)

Temperature

Operation:

0 to 10 °C(32 to 50 °F) no condensation

10 to 30 °C(50 to 86 °F) 95 %

30 to 40 °C(86 to 104 °F) 75 %

40 to 50 °C(104 to 122 °F) 45 %

storage

-20 to +60 °C(-4 to +140 °F). no condensation

10.2 Appendix B: Maintenance and Cleaning**10.2.1 Common Maintenance**

Do not store or place the instrument in locations where the liquid crystal display (LCD) may be directly exposed to the sunshine for a long time.

Be careful: Do not make spraying agent, liquid and solvent touch with probes to avoid the instrument or probe being damaged.

Cleaning

Inspect the instrument and the probe frequently in accordance with operating conditions. Clean the outer surface of the instrument according to the following steps:

1. Wipe off the floating dust outside of the instrument and the probe by using soft cloth.
When cleaning the LCD, do not scuff the transparent LCD protective screen.
2. Wipe the instrument in power off status by soft cloth that is moist but not dripping. It is

allowed to be cleaned by soft detergent or fresh water. Do not use any abrasive chemical detergent to avoid the instrument or the probe being damaged.





Warning: Before repowering and reuse, please confirm that the instrument has been dried out so as to avoid electrical short circuit and personal injury caused by moisture.

10.2.2 Storage of Oscilloscope

If the test tool is to be stored for a long time, it is required to charge the lithium battery before storage.

Charging the oscilloscope

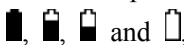
The lithium battery is possibly not charged when delivery. To make the battery with enough electric quantity, it must be charged for 6 hours (the test tool must be turned off during charging). The battery can supply power for 4 hours after being charged completely.

When supplying power by using the battery, a battery indicator is displayed on the top of the screen to show the consumption condition of electric quantity. The symbols that are possibly appear include , where  shows that the battery can only be used for about 5 minutes. To charge the battery and power the instrument, connect the oscilloscope using a power adapter according to Figure 1 to charge the battery. The charging speed can be increased by turning off the test tool.

Notice

To avoid superheat of battery during charging, the environment temperature is not allowed to exceed the permissible value given in technical specification.

Note:

No hazard will occur even connecting the charger for a long time, e.g. during a whole weekend. The instrument can automatically switch to slowly charging status.

10.2.3 Replacing the Lithium Battery Unit

It is usually not required to replace the battery unit. But when it is required to replace it, only qualified personnel can carry out this operation, and only use the same specification lithium battery.